

Letter Packs for Little Learners



Recognition – Sounds – Tracing – Stamping – Flash
Cards – Puzzles – Cut/Paste – Wearables – MORE

Hands-on letter activities and learning games for your Preschool and Pre-K
classroom.

Letters for little learners – LETTER D recognition, sound, tracing and craftivities

(Click on title)

Recognition

Color poster

Coloring pages

Follow letter maze (upper and lower case)

Sorting upper and lower case letters, using various fonts (cut and paste)

Sort 3 sizes of letters

Stamp the letters that look like the featured letter

Circle or X the letters that match the left column

I can draw a line to connect the Ds with the ds

I can stamp or color all the letters that look like this –D d

I can stamp or color the Ds red and the ds blue

I can cut and paste the Ds and the ds

Sounds

Letter character – meet Donald the Dog

Letter chant

Cut and paste initial sound pictures onto large letter

Word wall

Flash cards – 4 to a page

Math mats

Foldable little book for letter

Emergent reader for letter

Cut and paste squares

Tracing stamping and writing

Circle stampers on letter shapes

Tracing letters and pictures

I can rainbow trace the D and the d

Craftivities and kinesthetic learning

Letter necklace

Letter bracelets

Letter crown

Sort the letter D doughnuts into the jar

Play dough mats

Lacing large letter

Letter puzzle

Stick puppets

Graphics by [Whimsy Clips](#) and [Ashley Hughes](#) and [Creative Clips](#) and [Dancing Crayon Designs](#) and [Ink n Little Things](#) and [Little Red](#)

D d

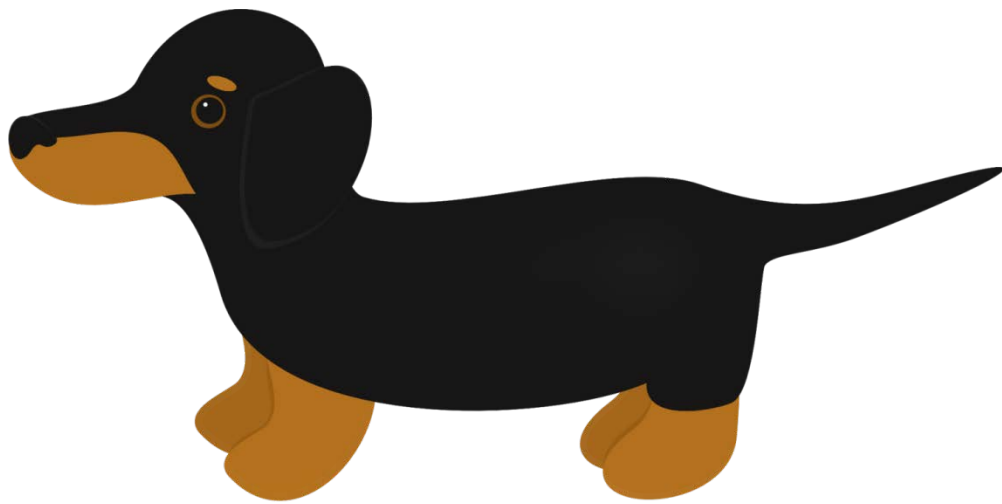

dog

D d

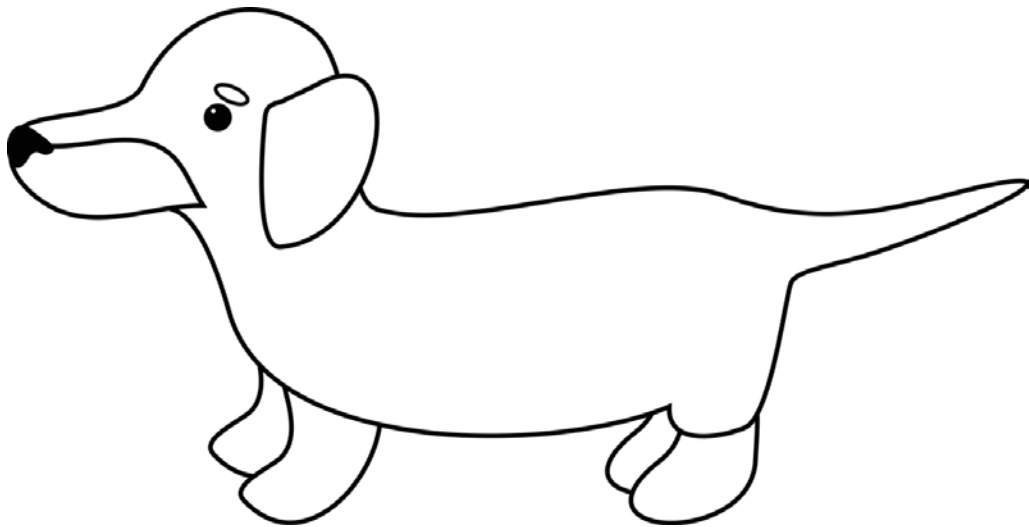

dog

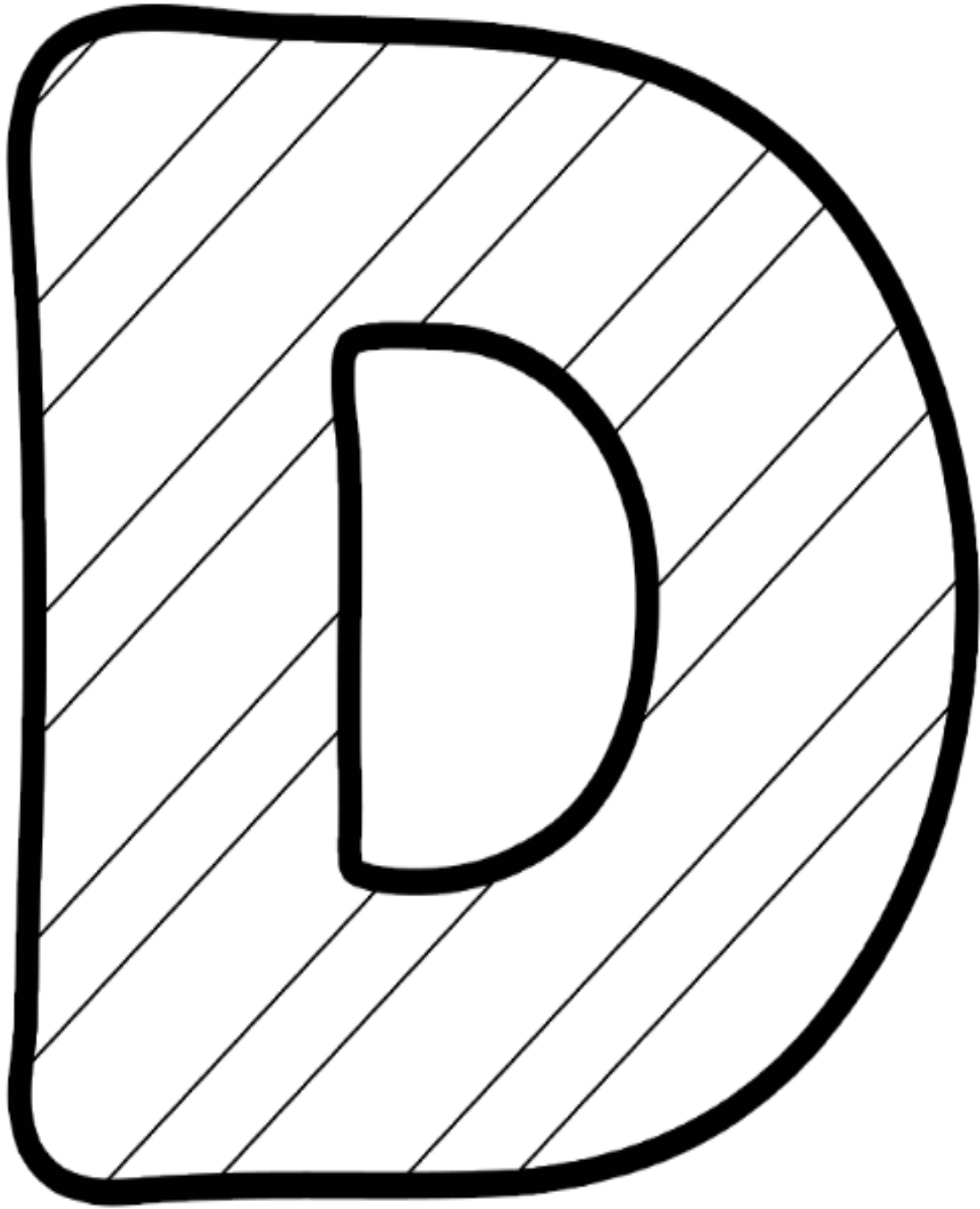

This is D.

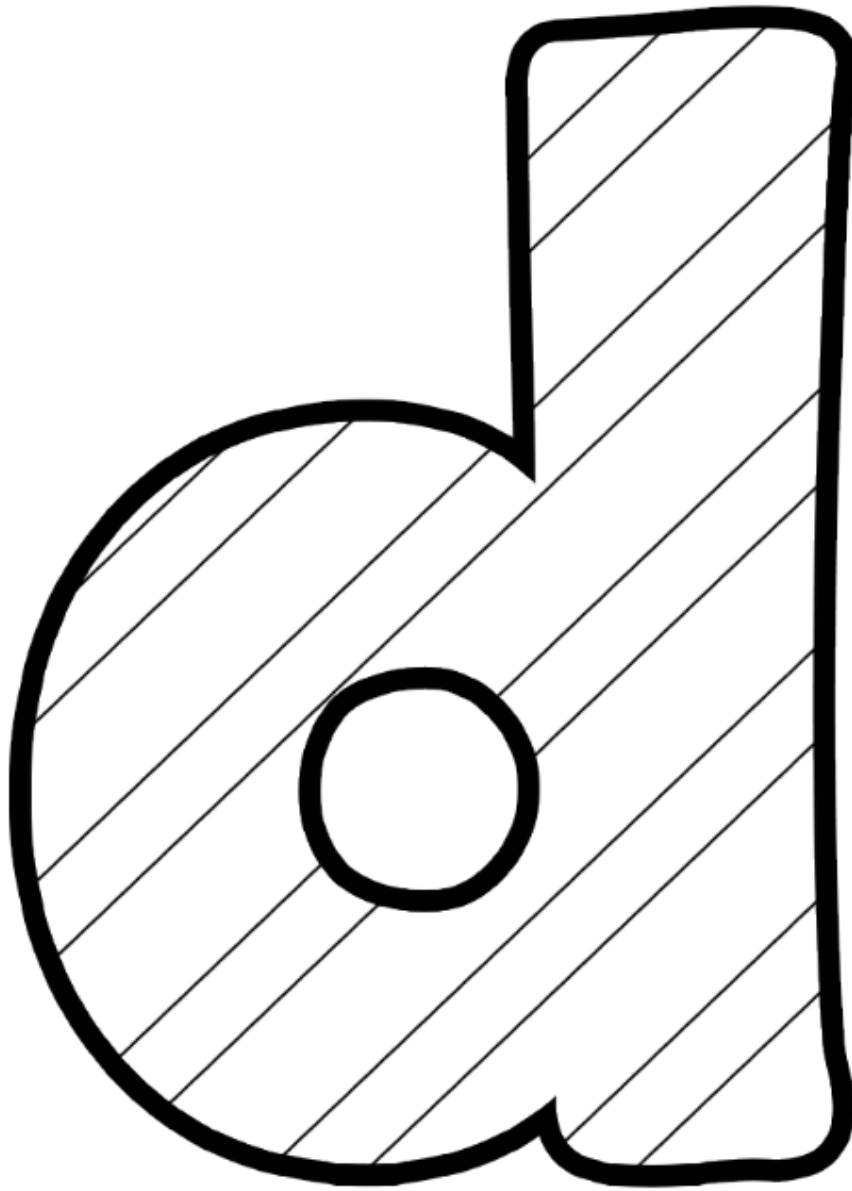

This is d.

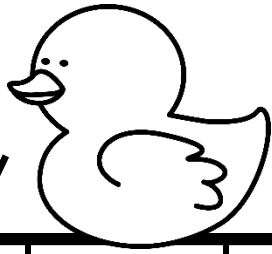

D	C	B	G	M	S	R
D	D	D	A	S	N	D
T	K	D	D	D	A	M
R	T	D	S	D	D	G
X	V	M	Z	F	D	D
W	D	B	S	H	C	D
D	M	S	E	P	A	D

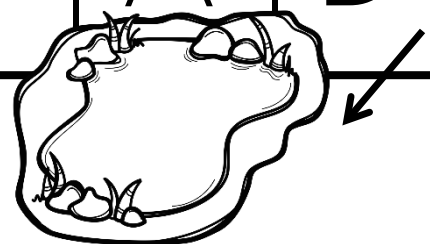

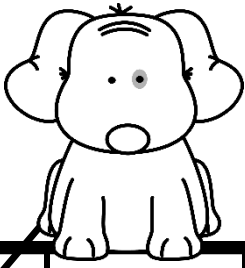

d	d	d	e	m	s	y
n	t	d	q	x	h	d
u	x	d	d	e	k	z
n	g	c	d	d	s	m
x	o	c	s	d	d	d
b	d	f	u	m	g	d
w	n	o	h	x	t	d

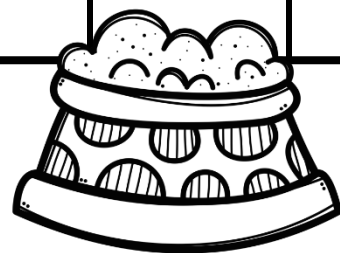

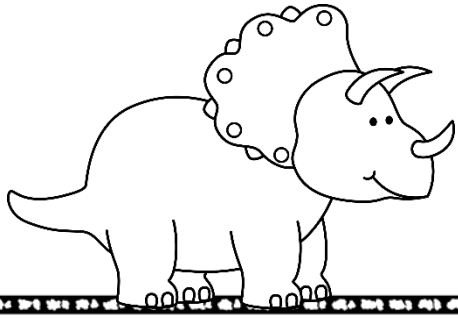

Dd

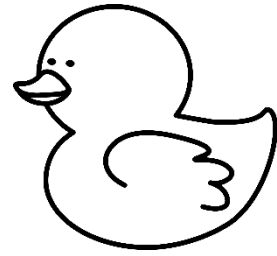

D

d

D

d

D

d

D

d

D

D

d

d

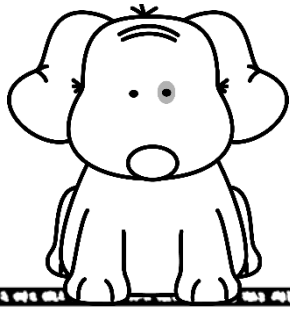

Dd

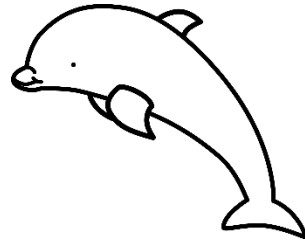

D

d

D

d

D

d

D

d

D

d

D

d

big

medium

small

D

D

D

D

C

D

D

D

D

D

D

D

D

D

D

D

D

d

d

d

d

d

d

d

d

d

d

d

d

d

d

d

d

d

I can cut and paste the D and the d

D

d

D	d	T	d
E	y	D	h
m	d	D	V
d	D	d	D
D	D	d	d

Stamp or color all the letters that look like this:

D

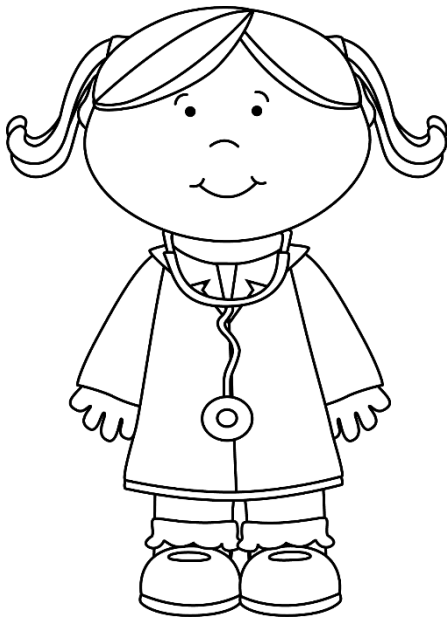
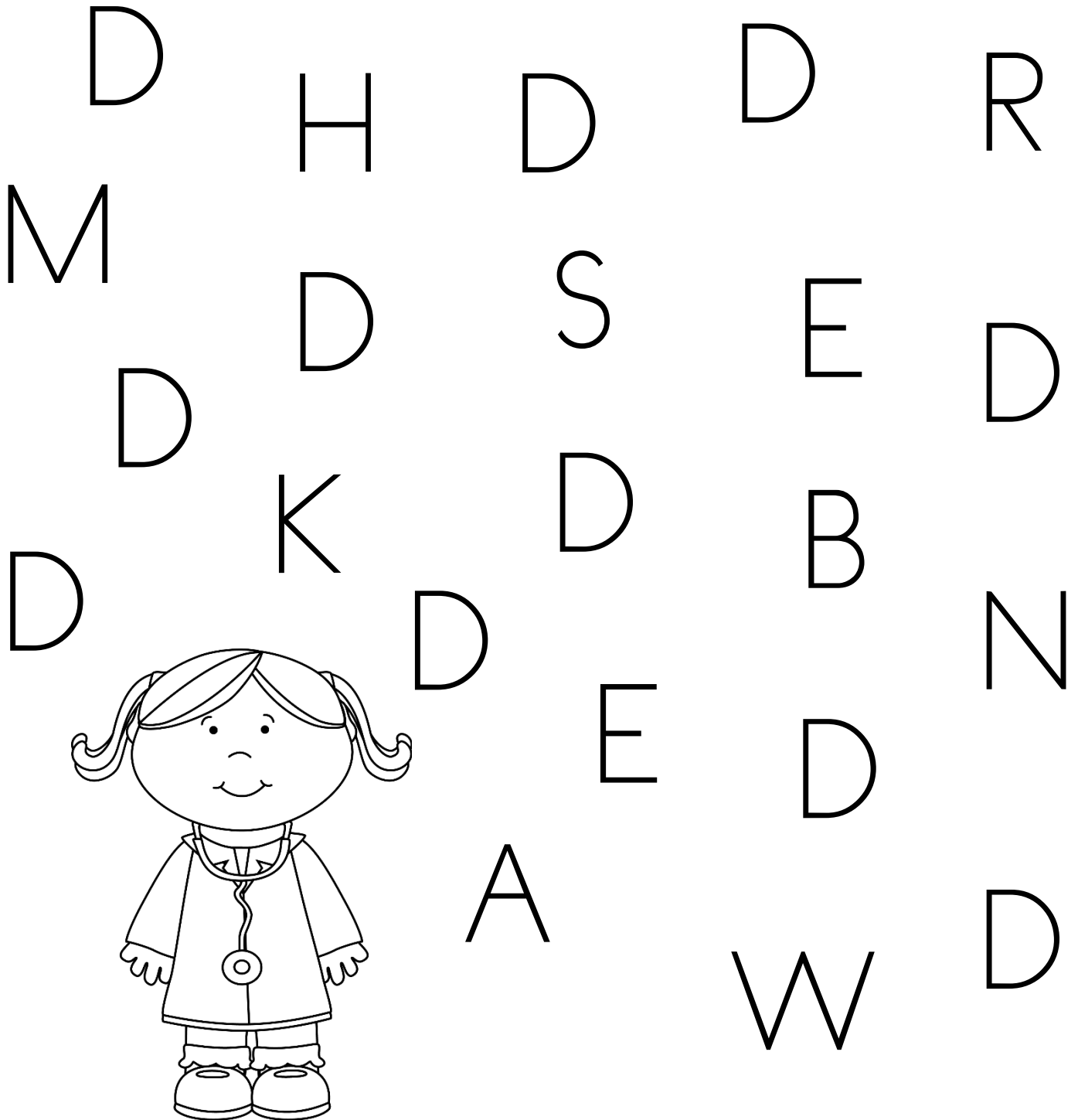

Stamp or color all the letters that look like this:

d

h

d

n

d

d

d

d

d

e

n

d

d

r

t

d

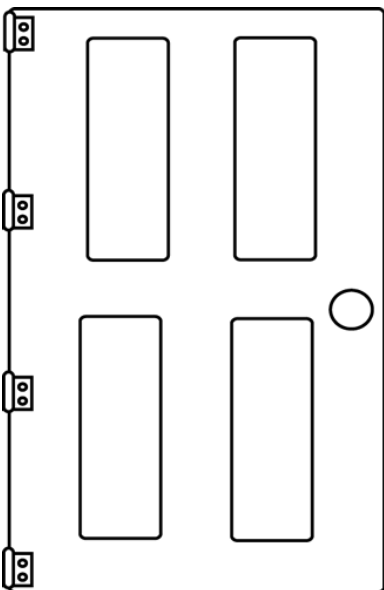

d

w

z

d

k

I can stamp or color all the letters that look like this:

D d

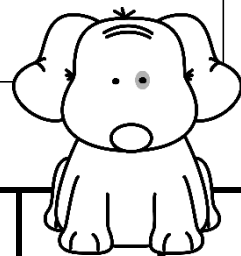

D	D	Z	B	d	d
A	e	D	d	D	a
d	D	d	D	E	d
D	D	d	M	b	D
L	r	D	d	D	N
d	D	d	B	w	d

Circle or X the letters that match the left column.

D

D n B o D z v D n

D

D D s A P k m D

D

G D K D p t h x D

d

d d P E d K M d

d

T d M d d M w d

d

A d d P d S F d x

I can stamp or color the D red.

I can stamp or color the d blue.

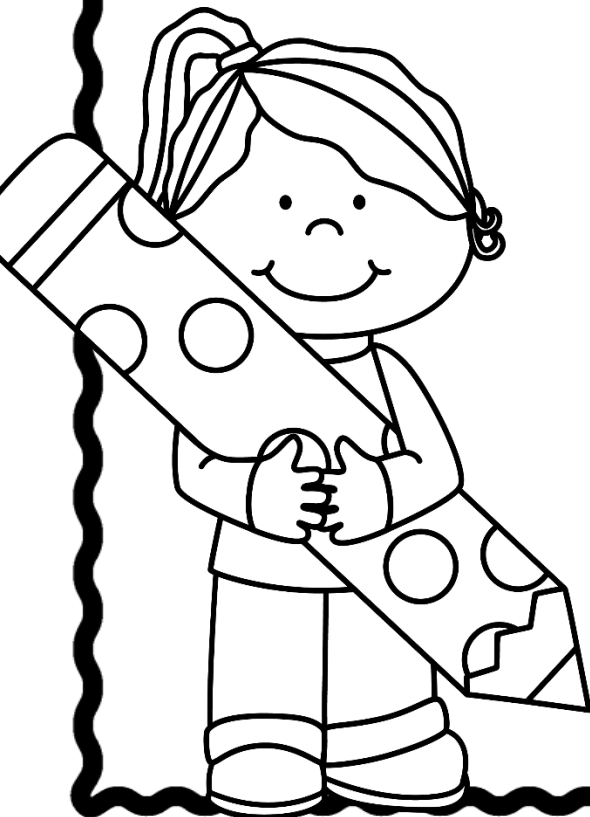
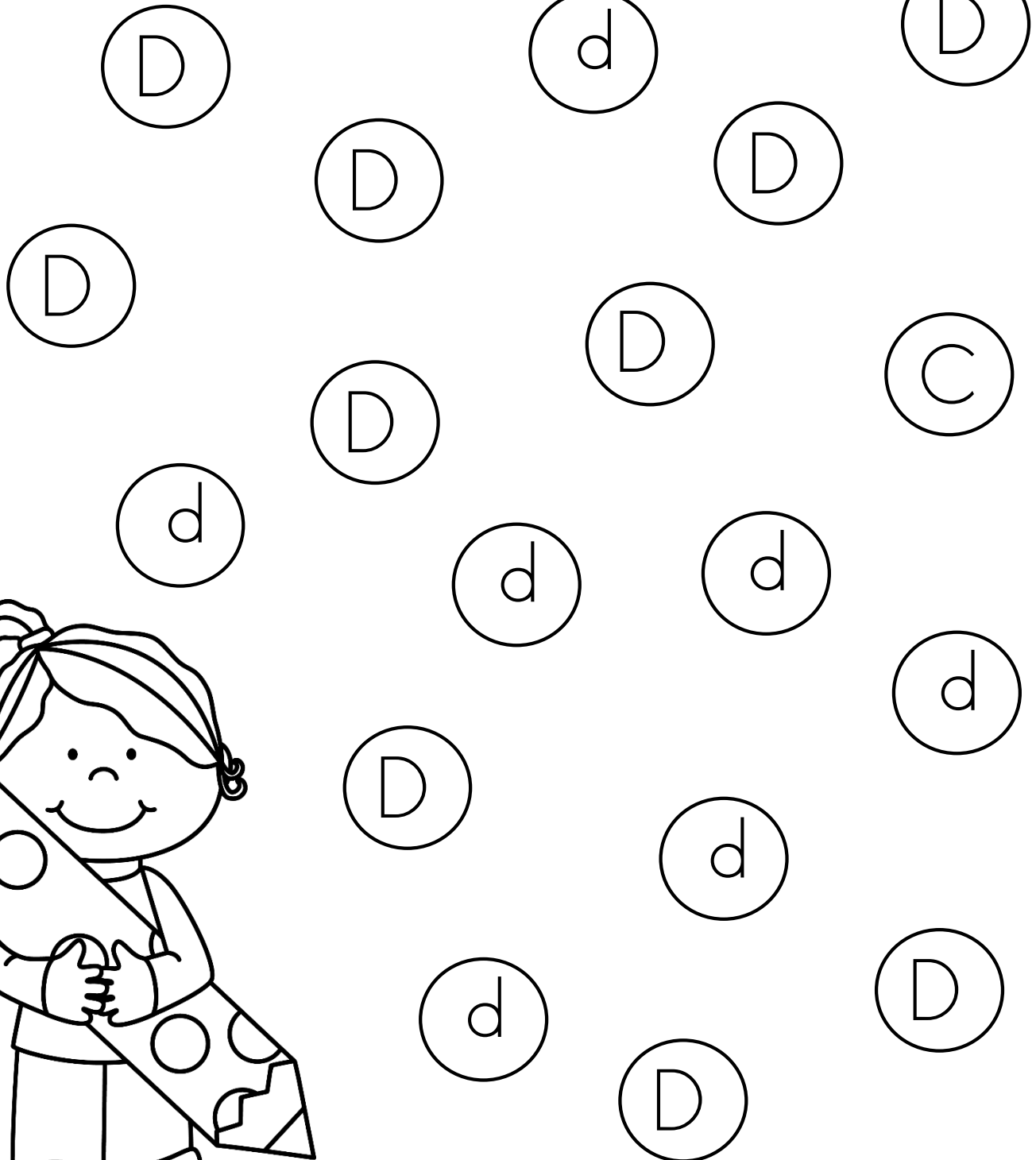

I can draw a line to connect the D with d

D

d

B

n

D

d

D

d

D

e

V

d

D

d

I can draw a line to connect the d with D

d

D

d

n

d

D

b

D

d

e

d

D

e

D



Donald the Dog loves the letter D.
He also loves delicious doughnuts and
daily dances.



Donald the Dog,
Donald the Dog,

Went to the lake and
he caught a big
frog!

D D Donald

D D Dog!



Croak!!

Dd

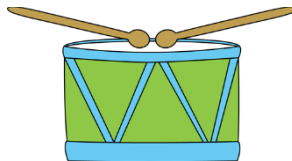
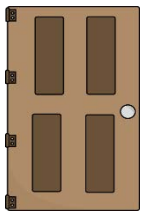
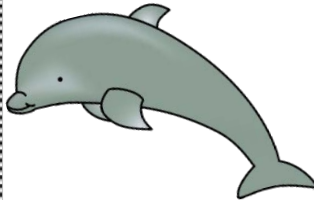
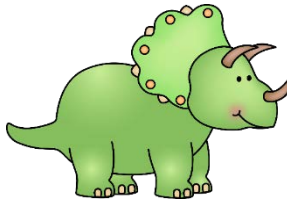
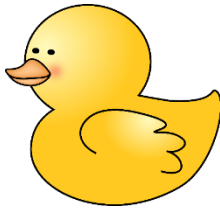
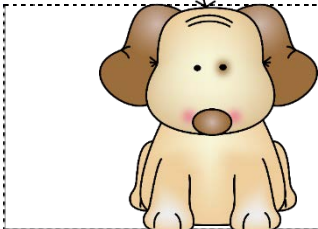
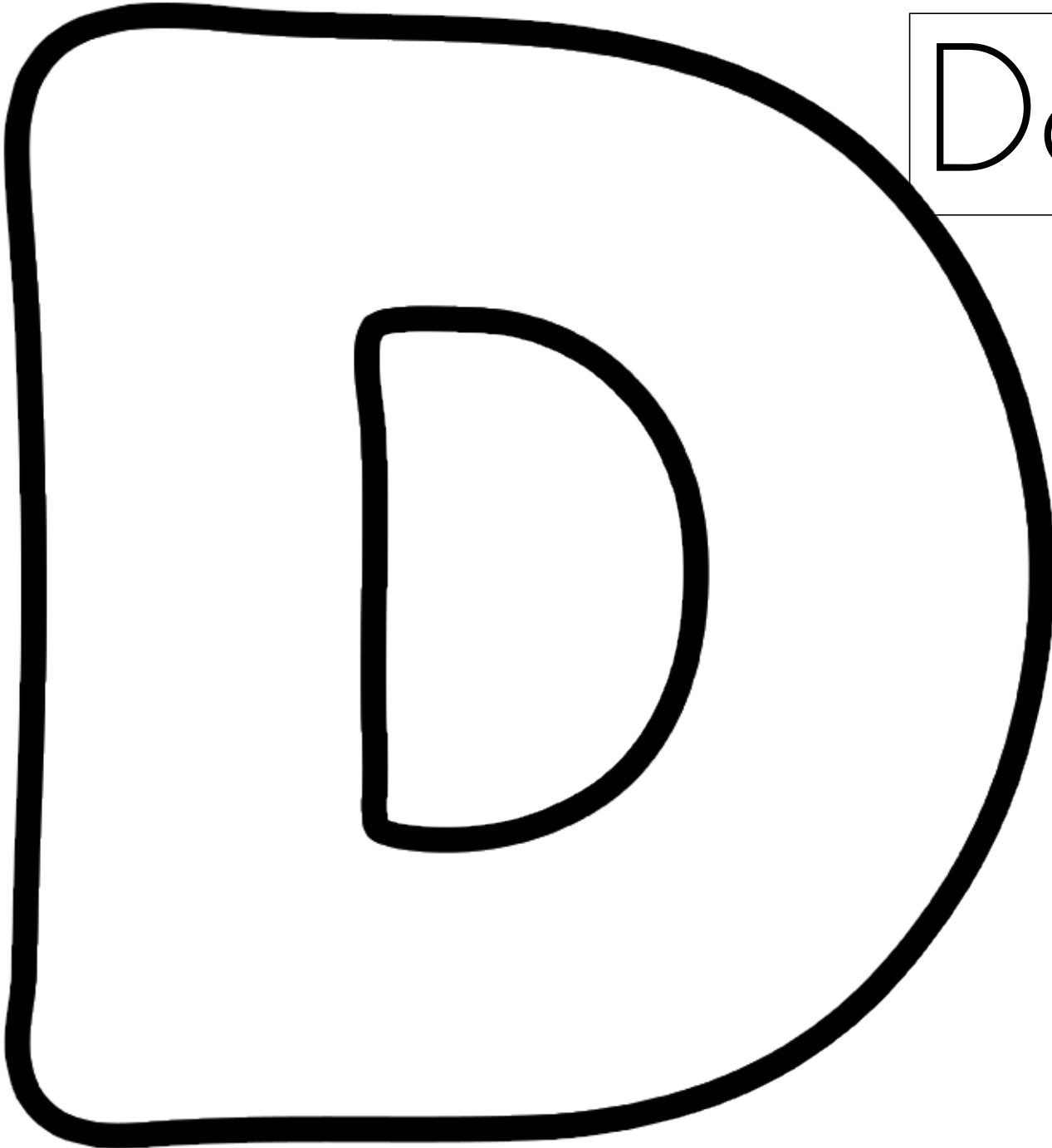

Dd is for
dolphin.

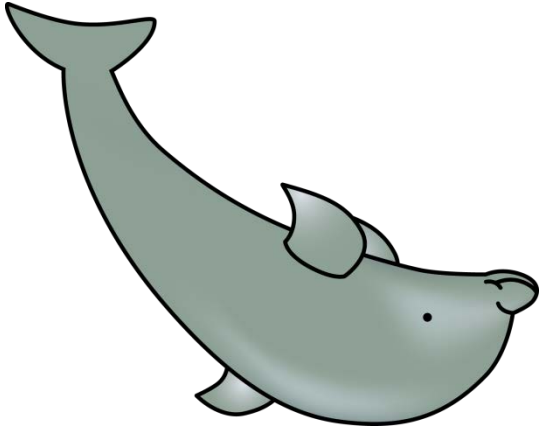

Dd is for
duck.

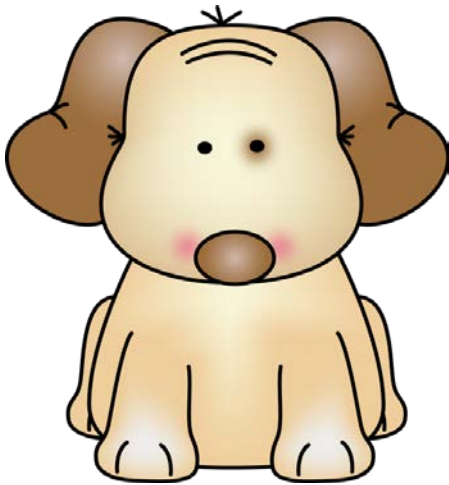
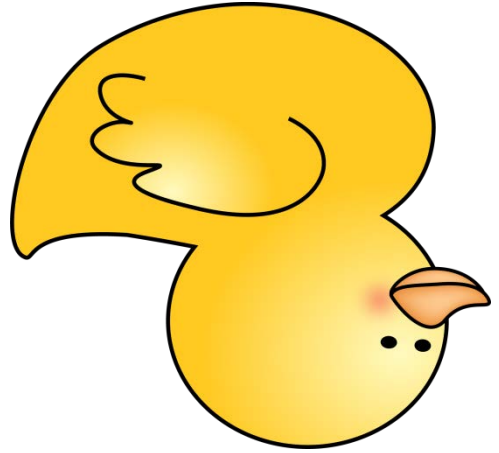

Dd is for dog.

My Little Book
About

Dd

Name: _____

dolphin

Dd is for

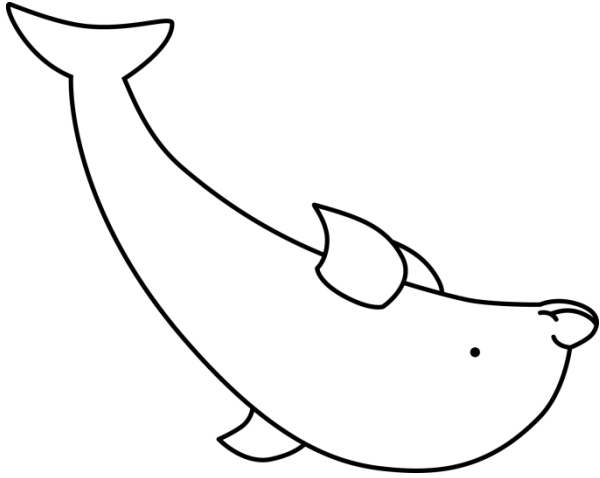

duck.

Dd is for

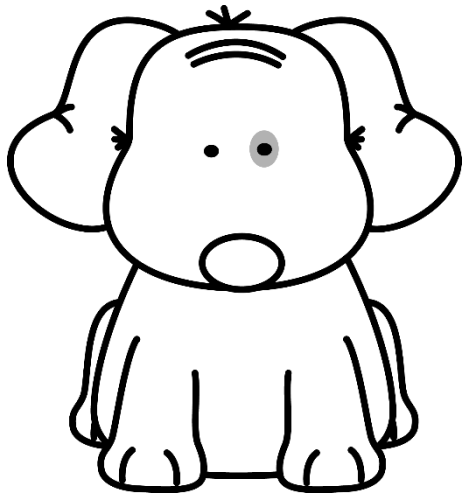
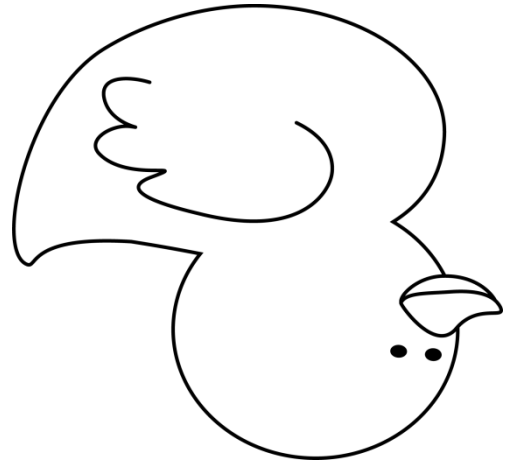

Dd is for dog.

My Little Book
About

Dd

Name: _____

Name: _____

	Dd	

Cut and paste squares



dog

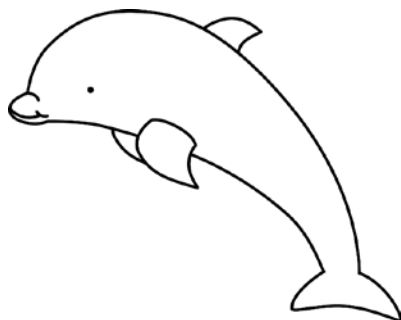

dolphin

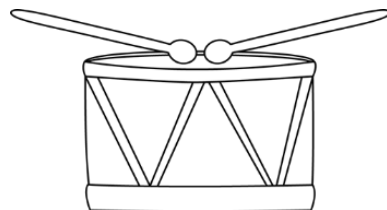

drum



doctor

Dd

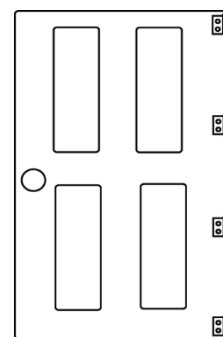

door

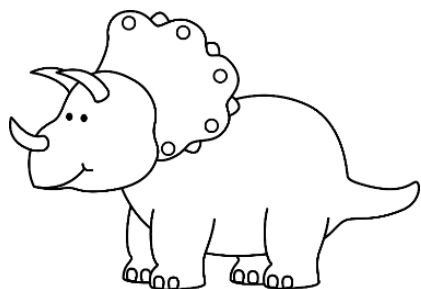

dinosaur

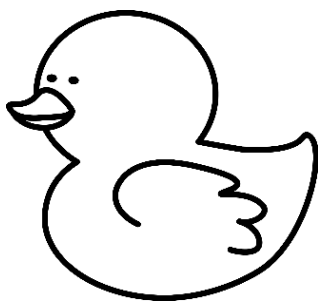

duck

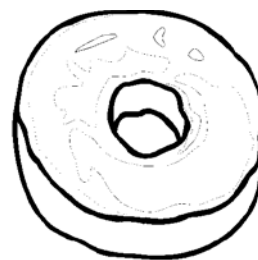

doughnut

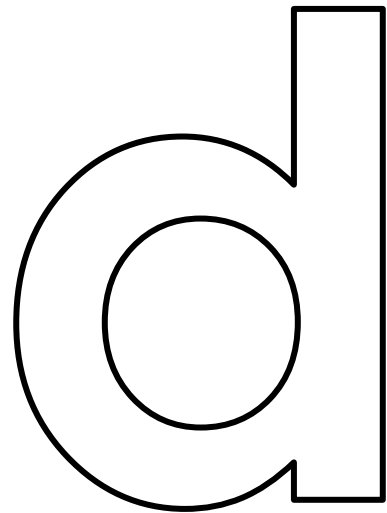
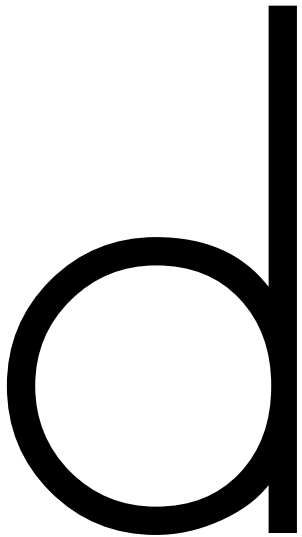
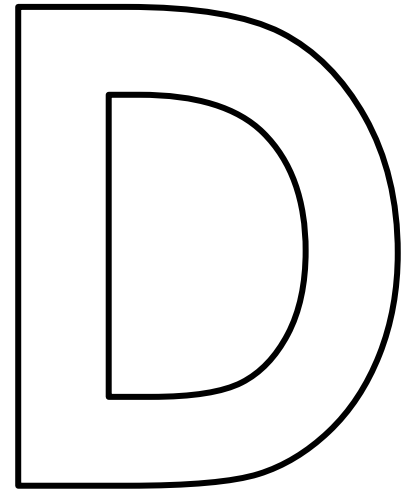
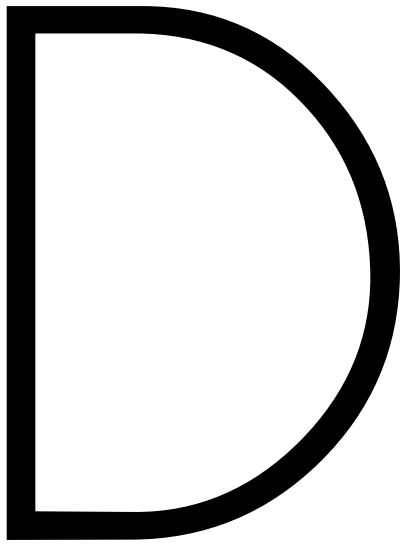

Dd



dog

Dd

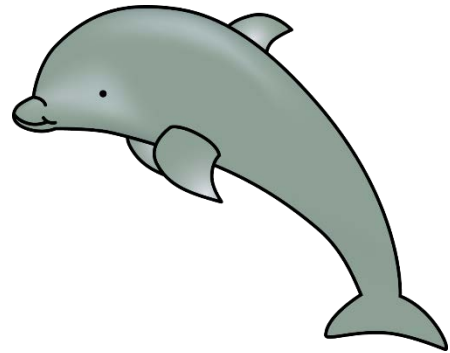

dolphin

Dd

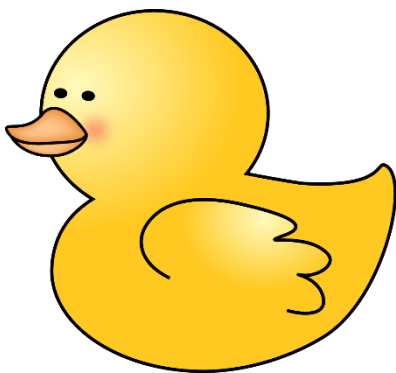

duck

Dd

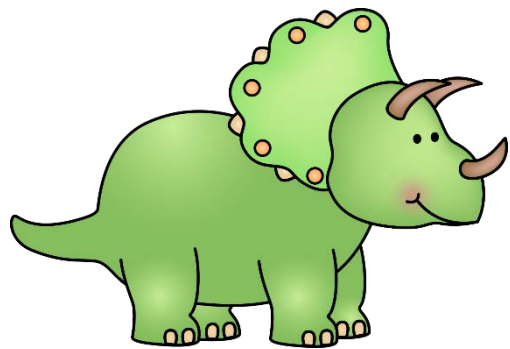

dinosaur

Dd



doctor

Dd

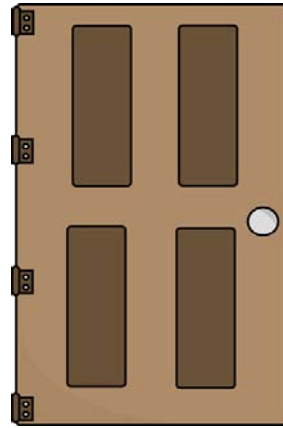

door

Dd

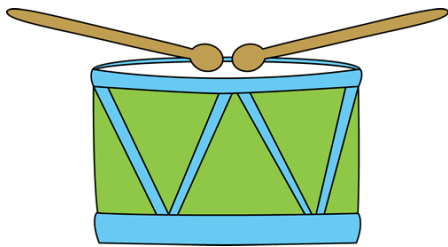

drum

Dd



doughnut

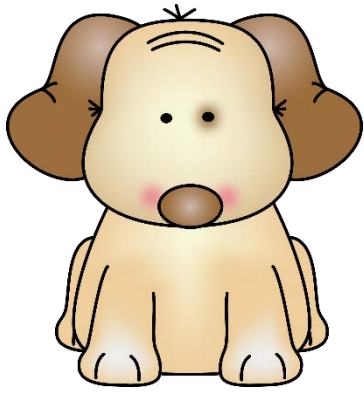

dog

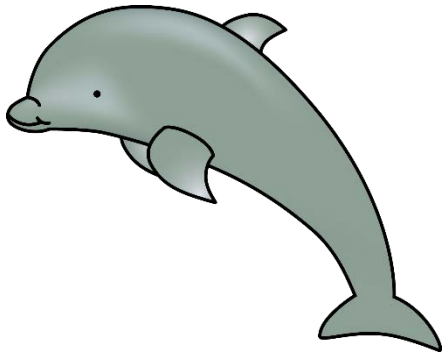

dolphin

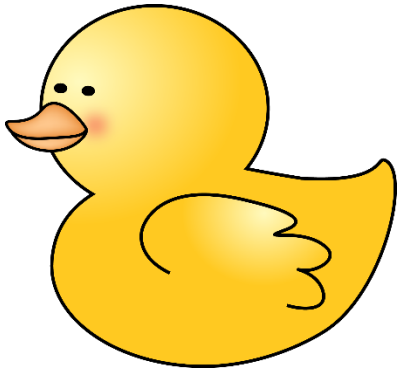

duck

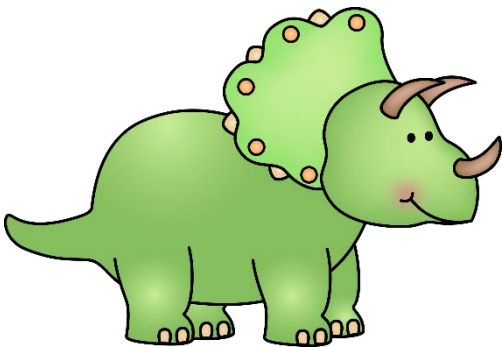

dinosaur

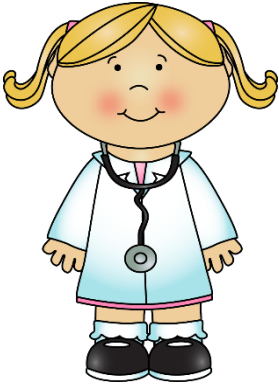

doctor

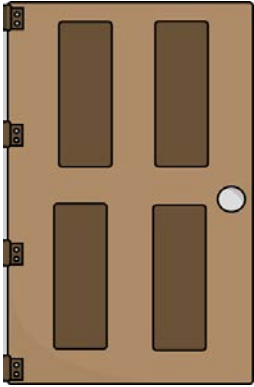

door

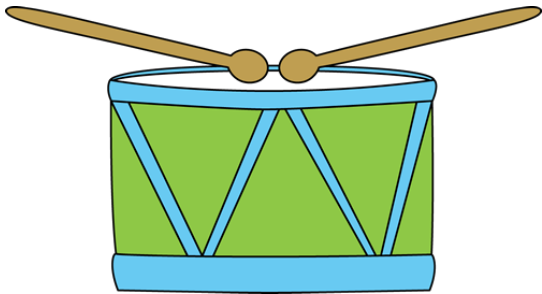

drum



doughnut

My Book About

Dd

Name: _____

My Book About

Dd

Name: _____

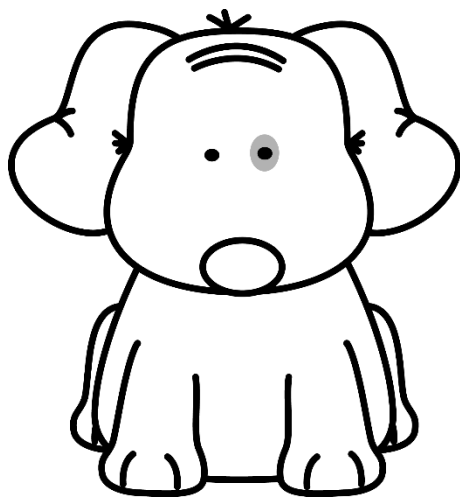

I see a dog.

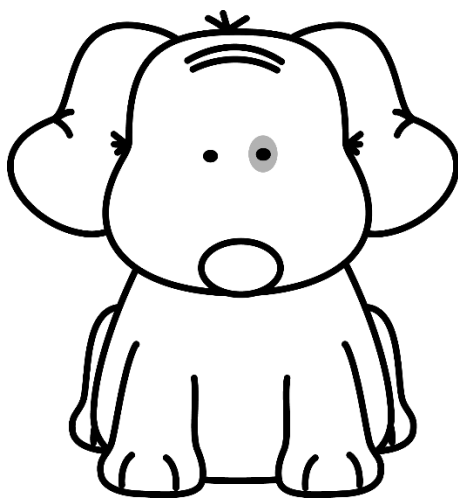

I see a dog.

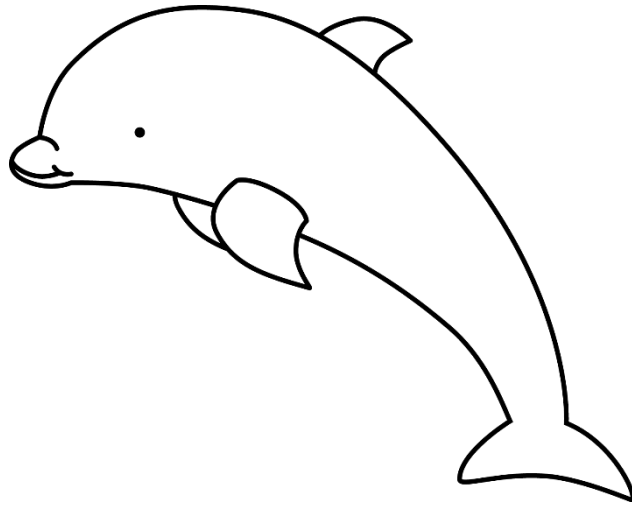

I see a dolphin.

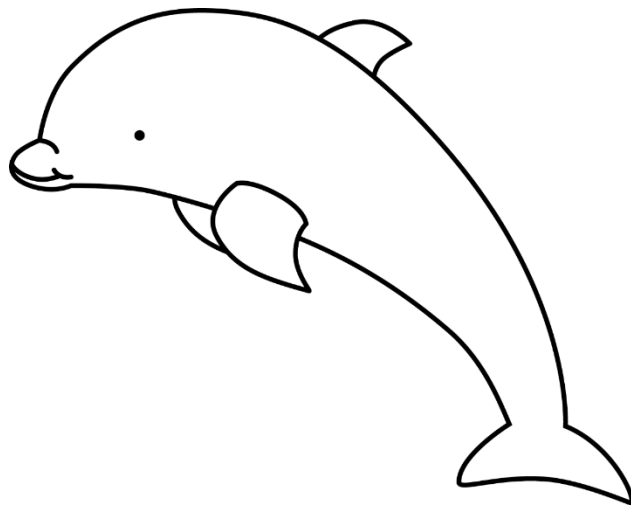

I see a dolphin.

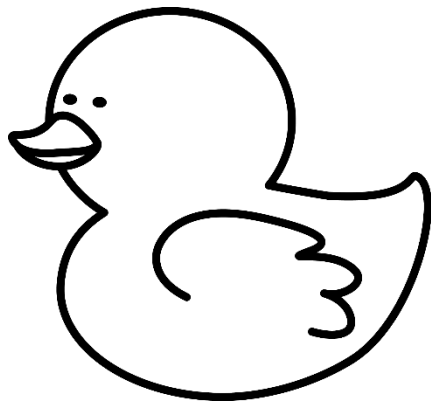

I see a duck.

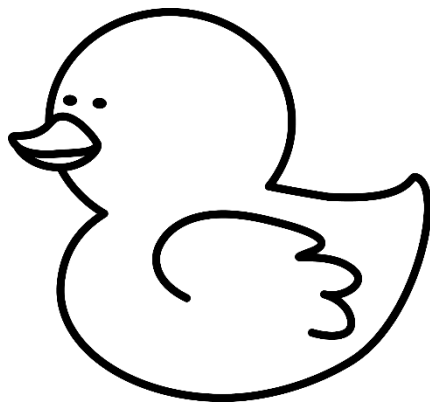

I see a duck.

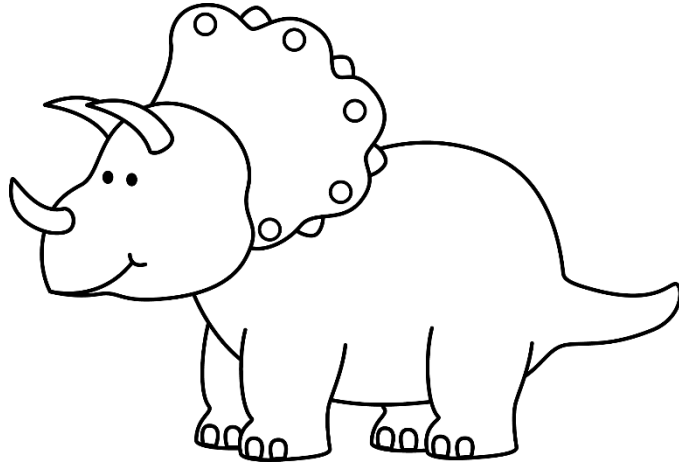

I see a dinosaur.

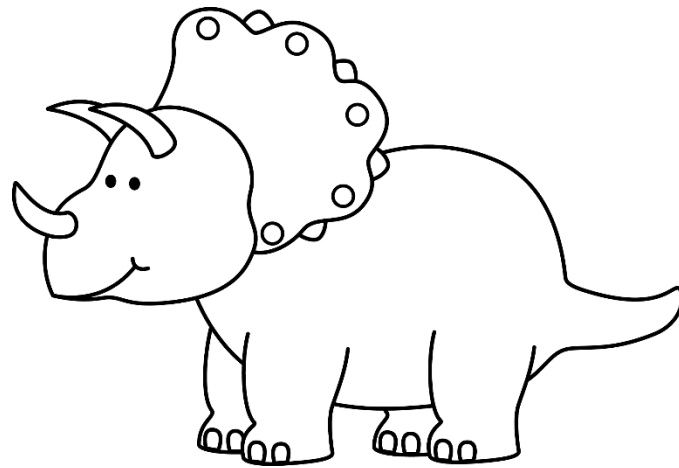

I see a dinosaur.

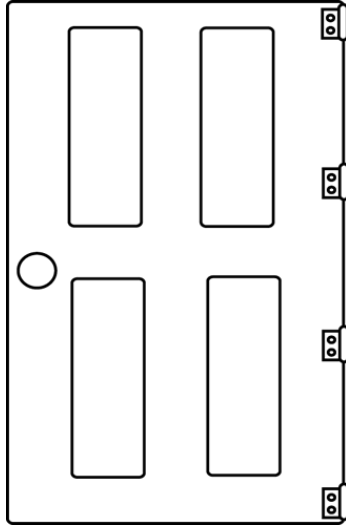

I see a door.

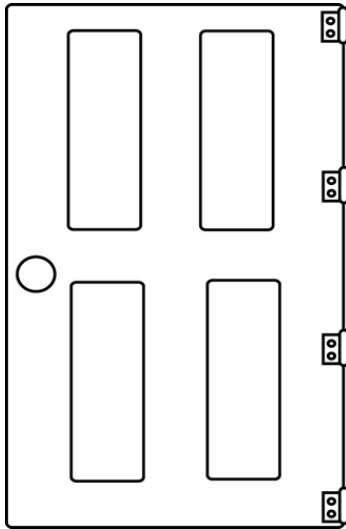

I see a door.

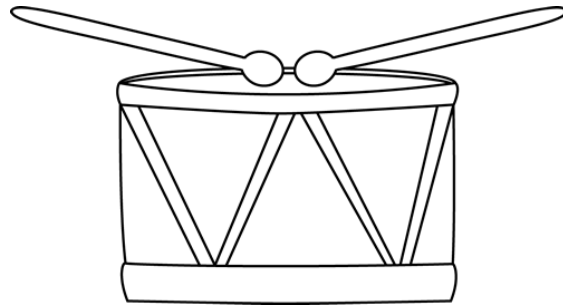

I see a drum.

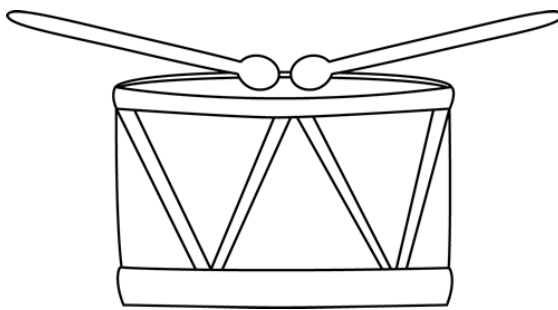

I see a drum.

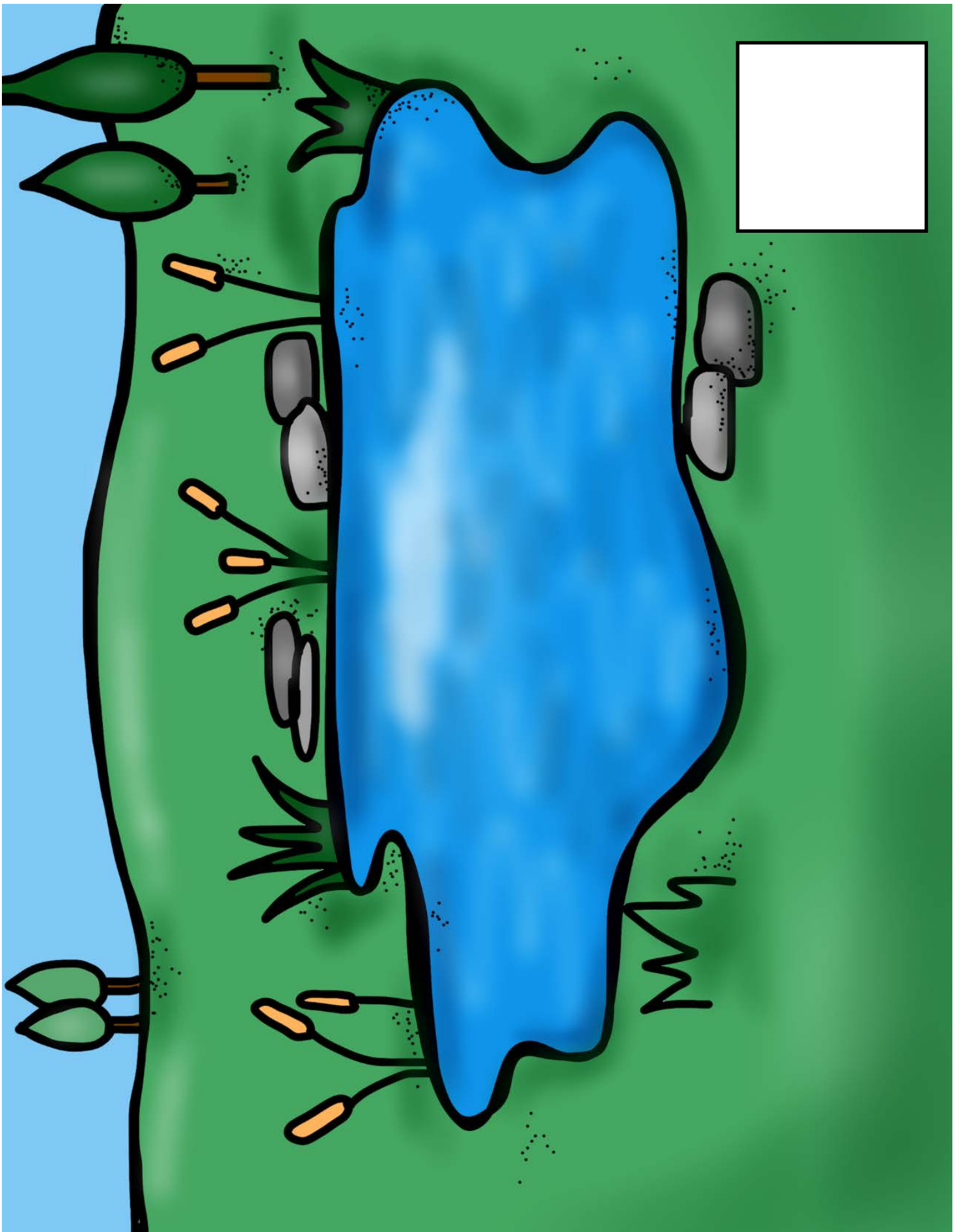

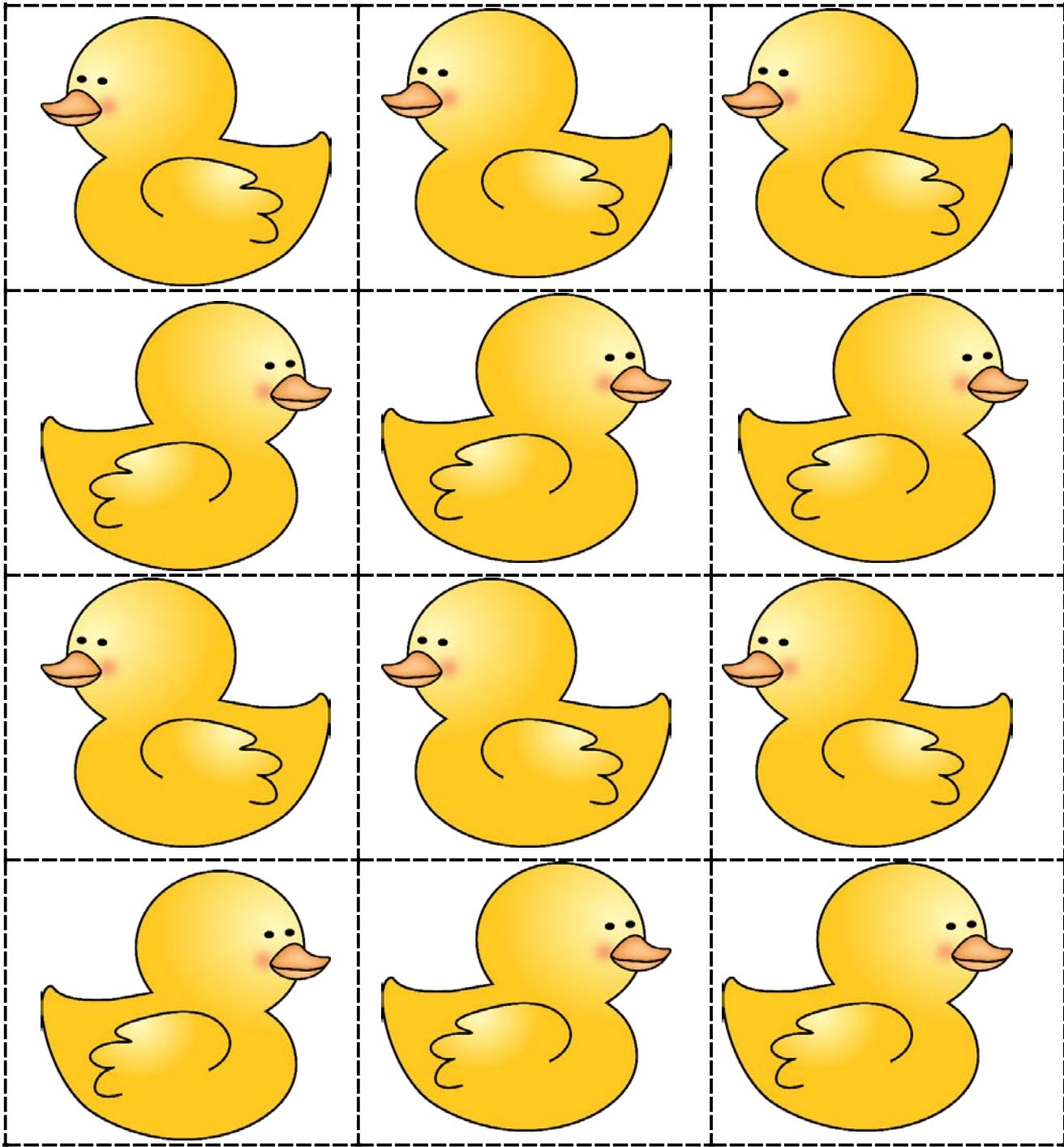

Math Mats – Print as many mats as you need, write a number in the square in the right corner. Cut out the ducks and count them onto the mats according to the number.

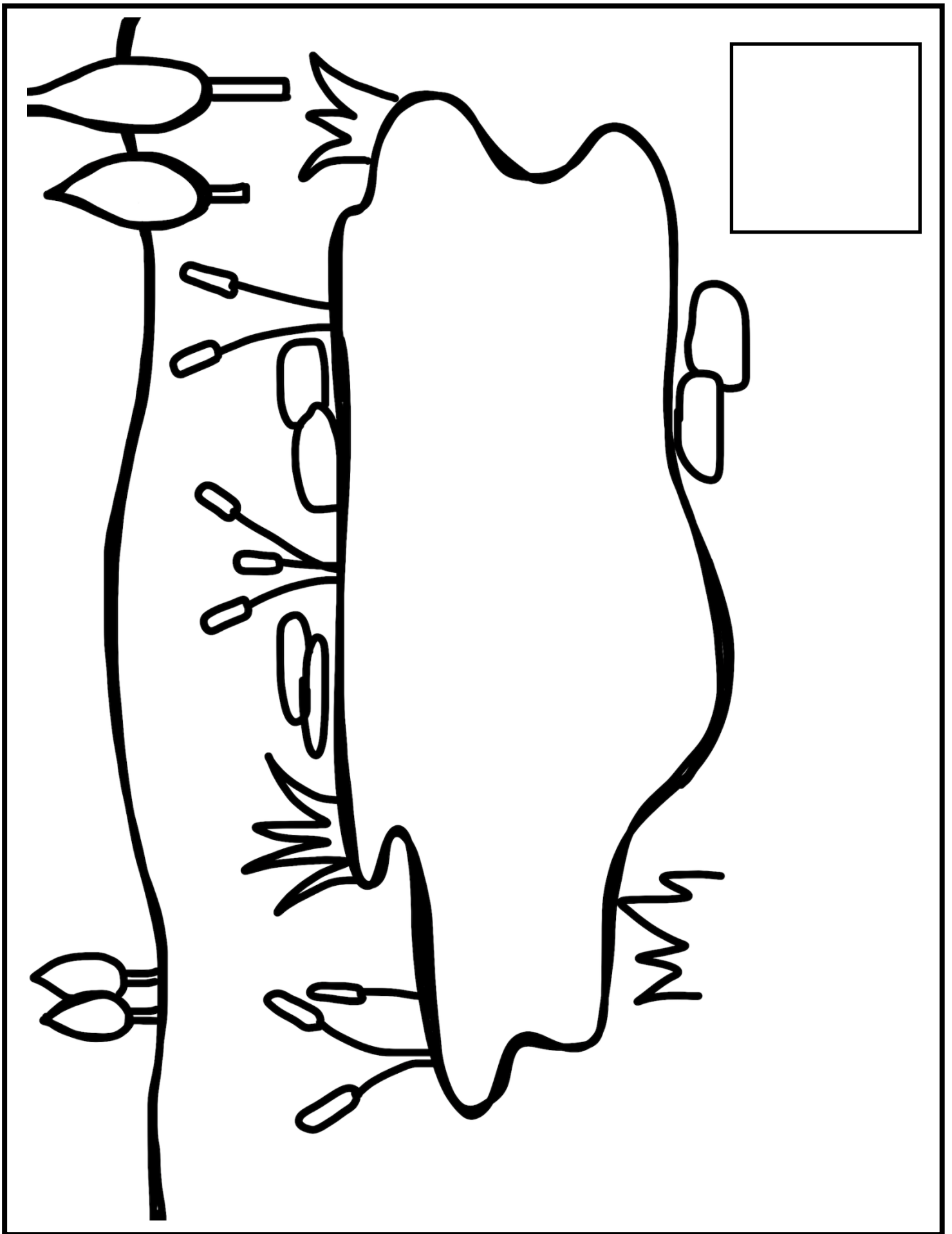

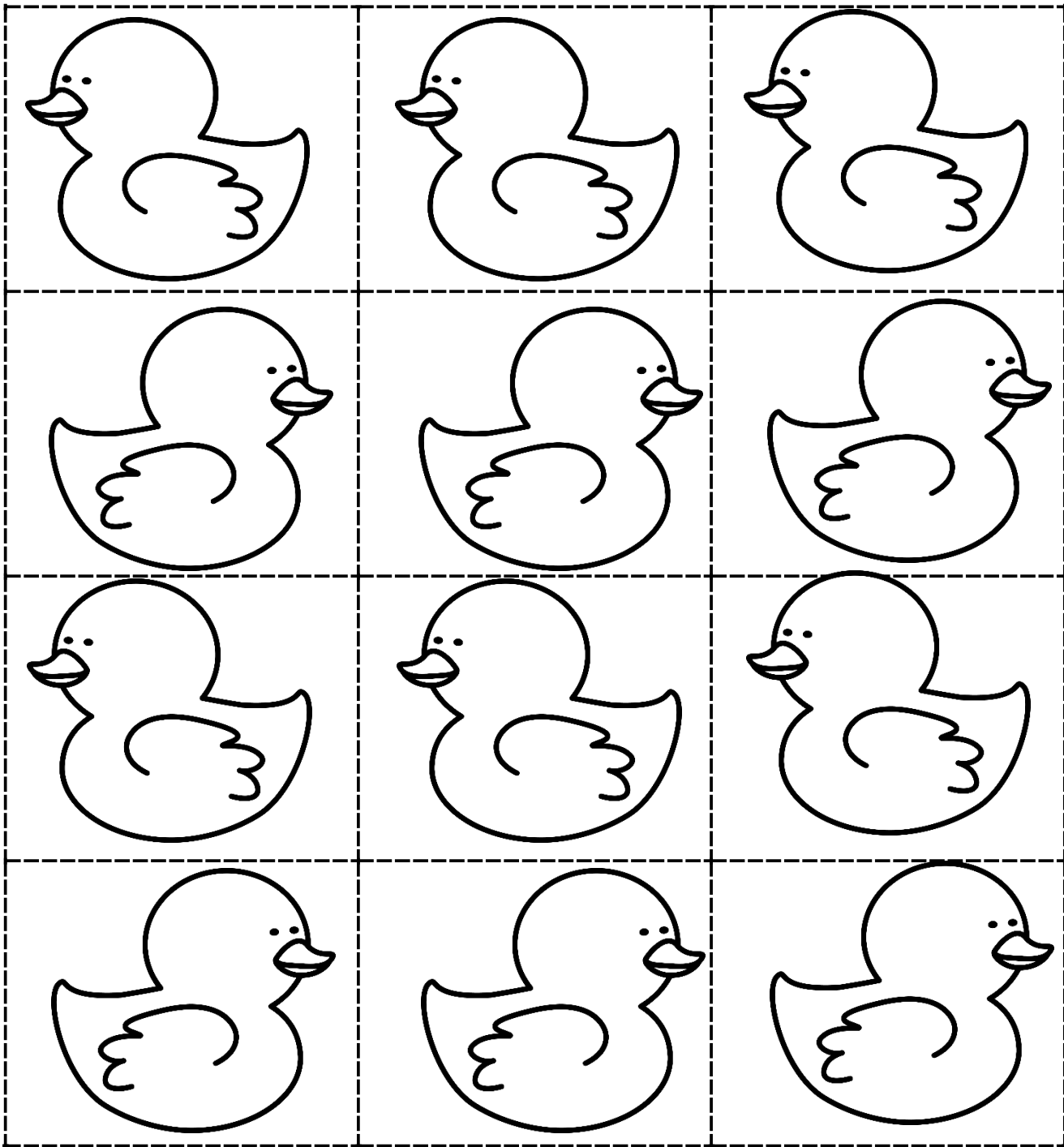

Math Mats – Print as many mats as you need, write a number in the square in the right corner. Cut out the ducks and count them onto the mats according to the number.

Letter D stamping – use a bingo dauber, stickers or finger prints on the circles.

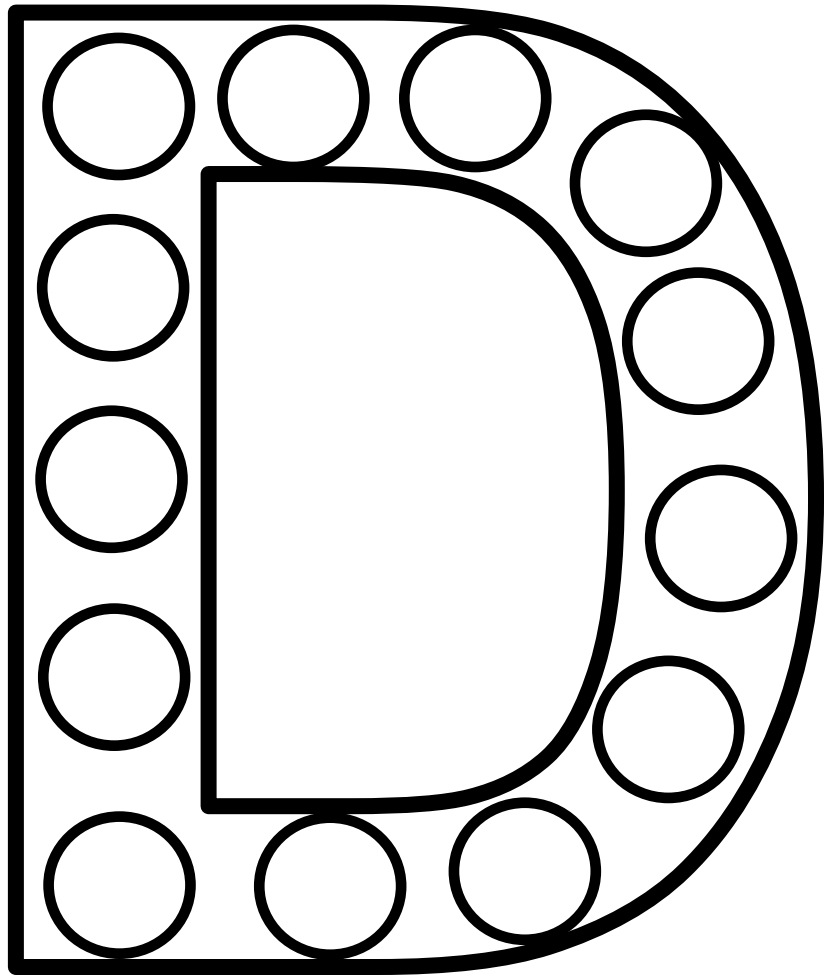

D

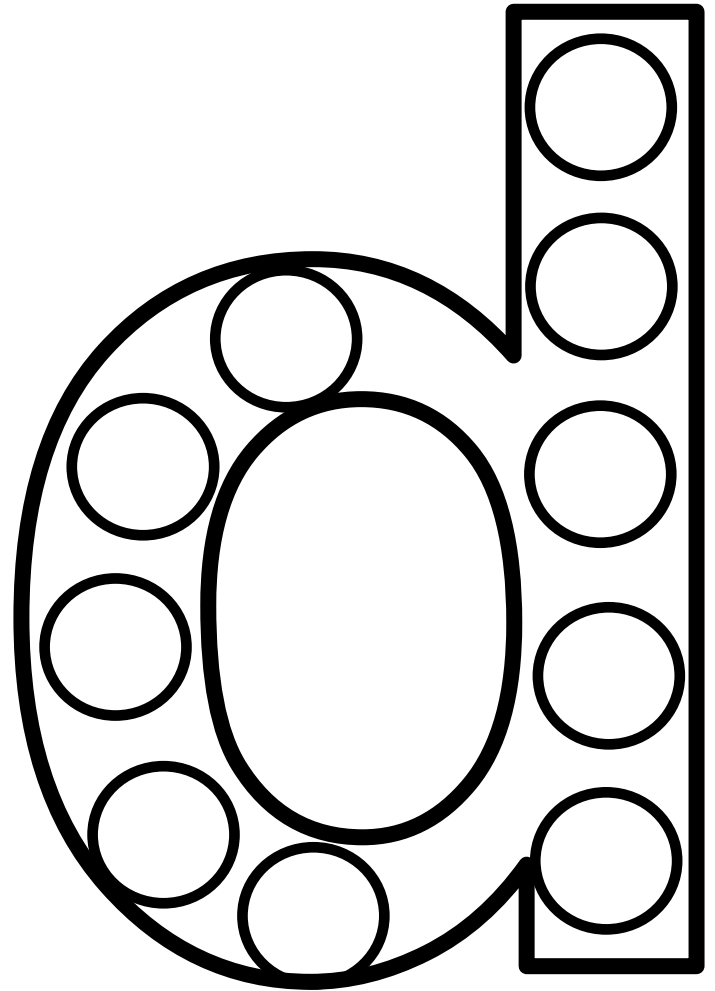

d

I can rainbow trace D and d.

D

D

D

d

d

d

D

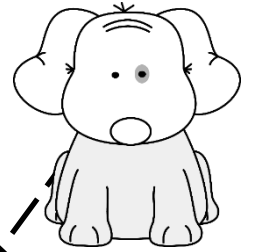
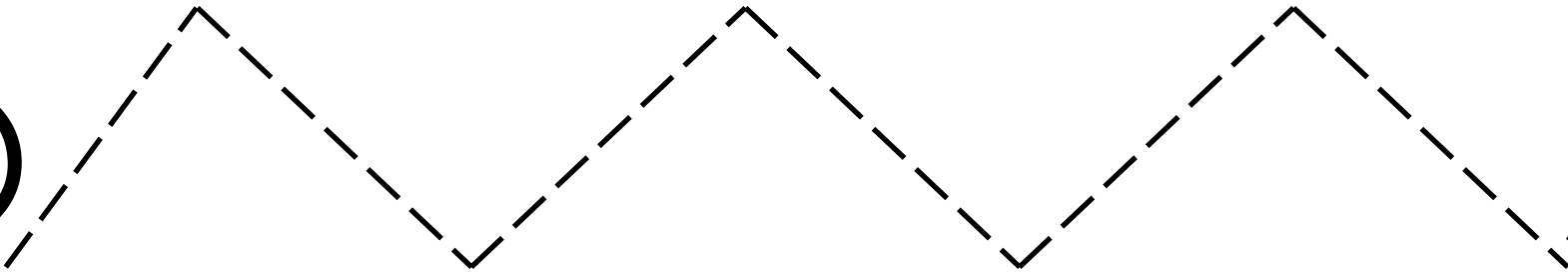

D

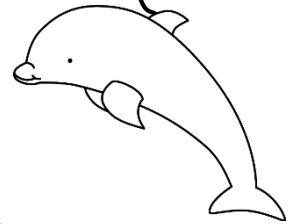
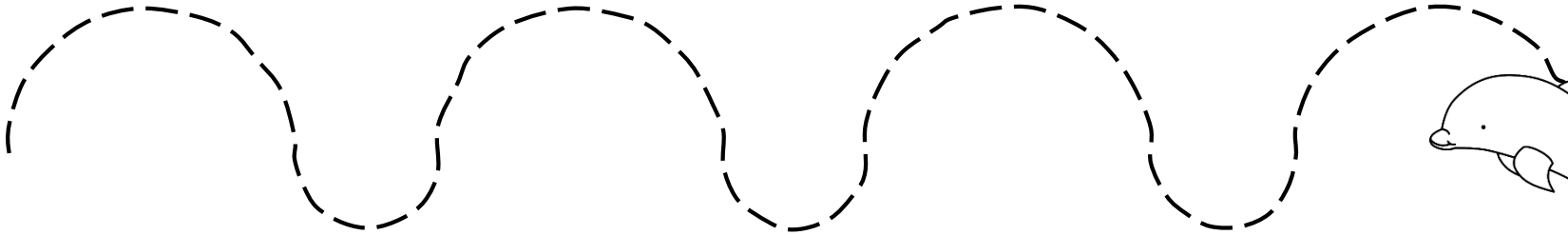

D

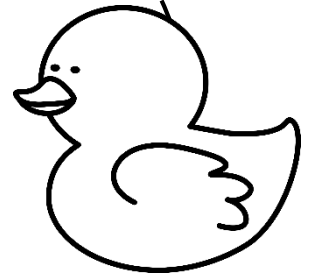
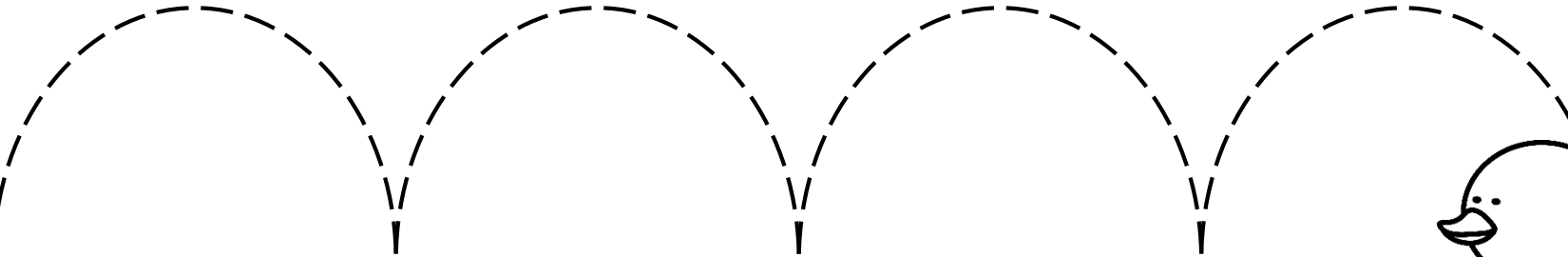

D

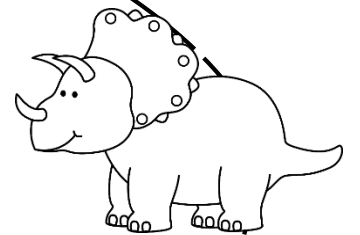
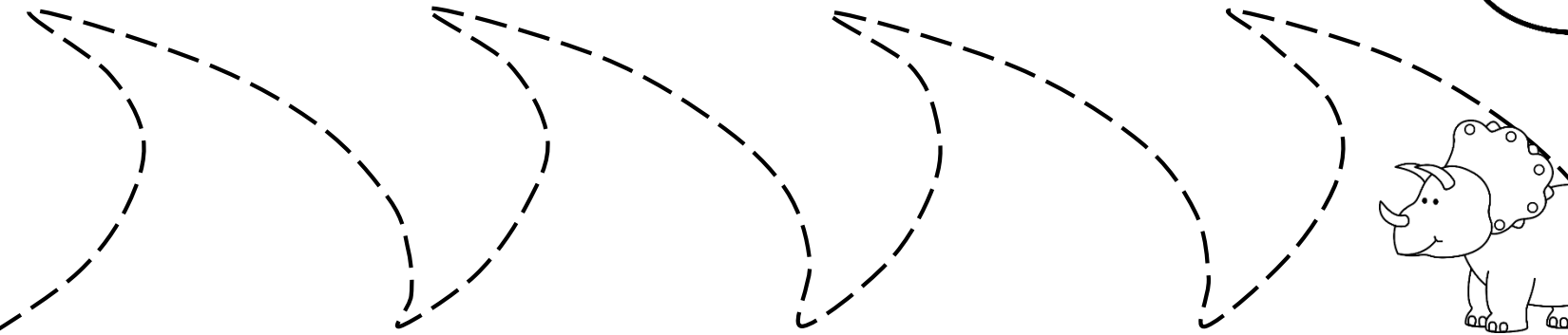

d

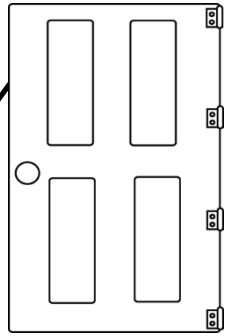
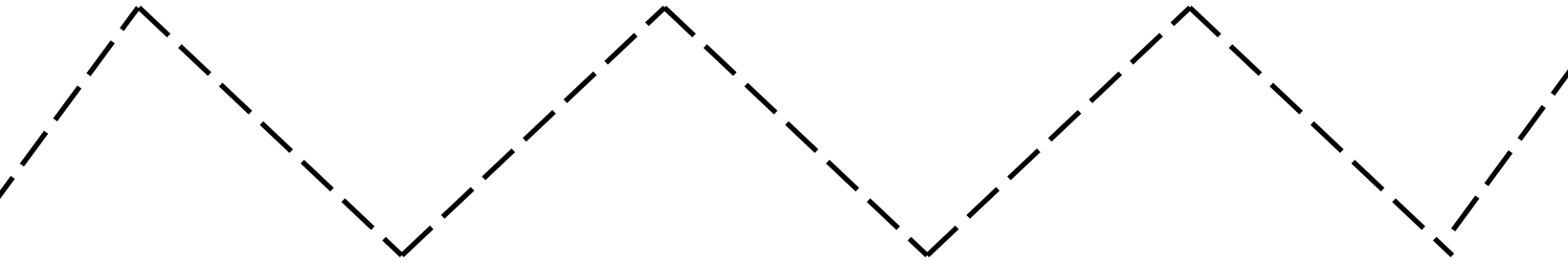

d

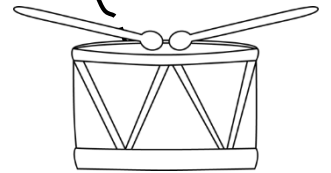
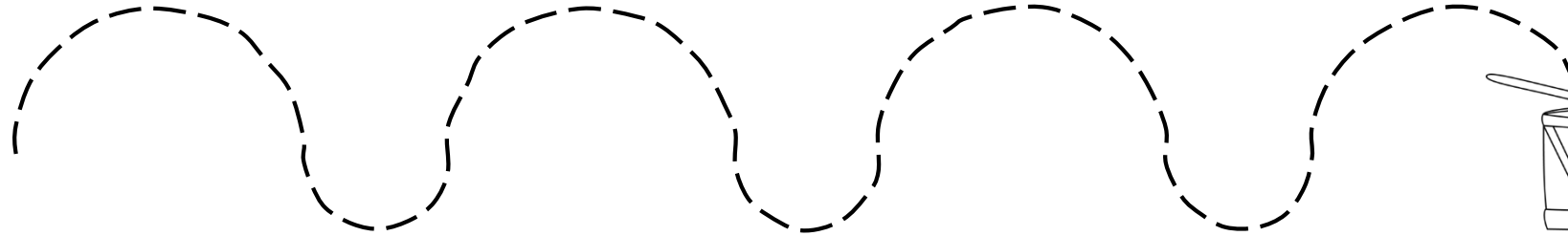

d

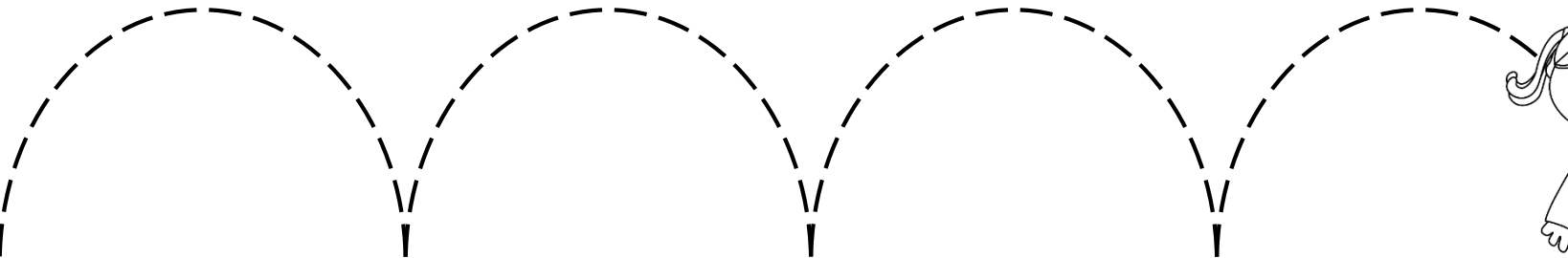

d

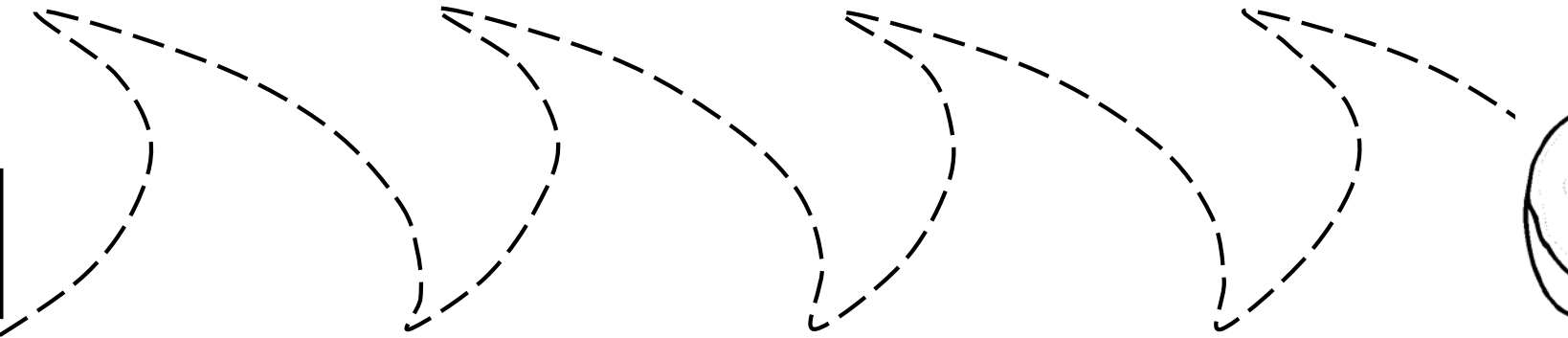

Dd

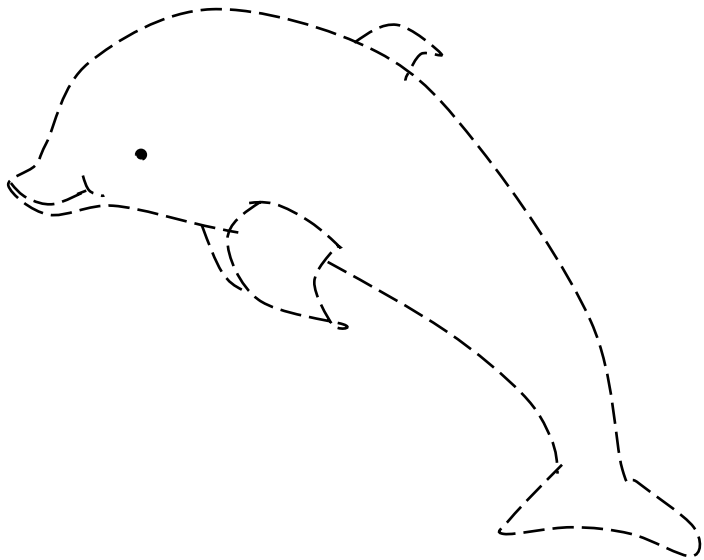

Dd

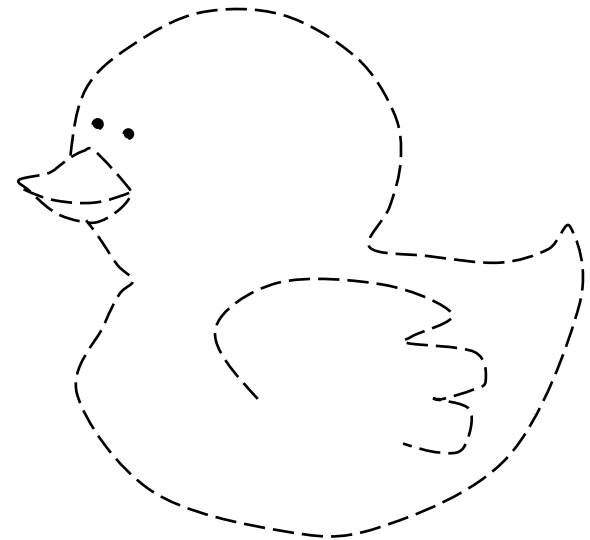

D d

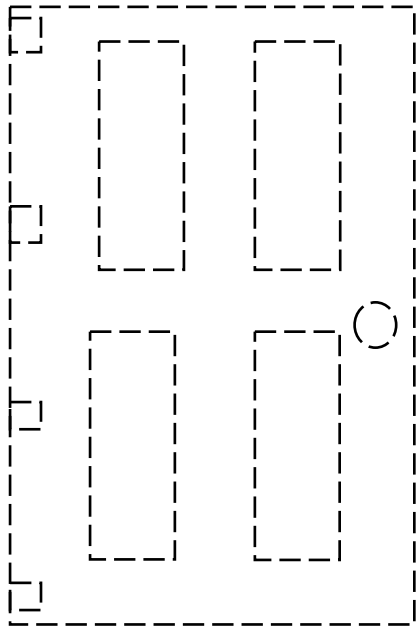

D d

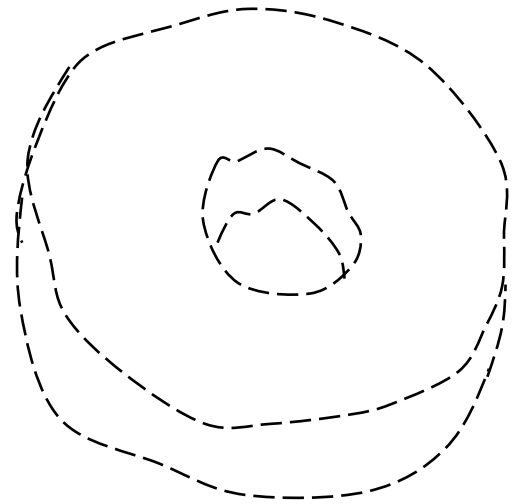

Name: _____

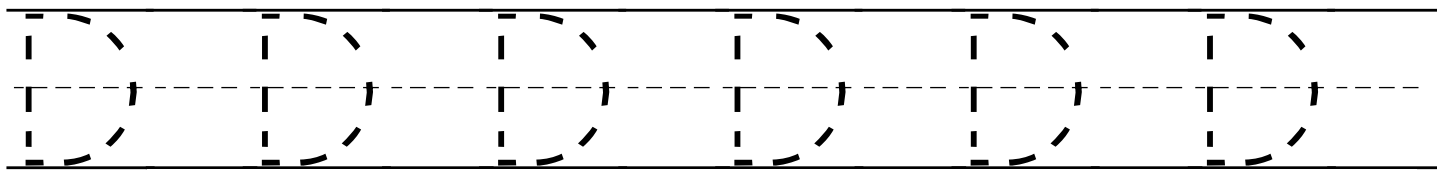
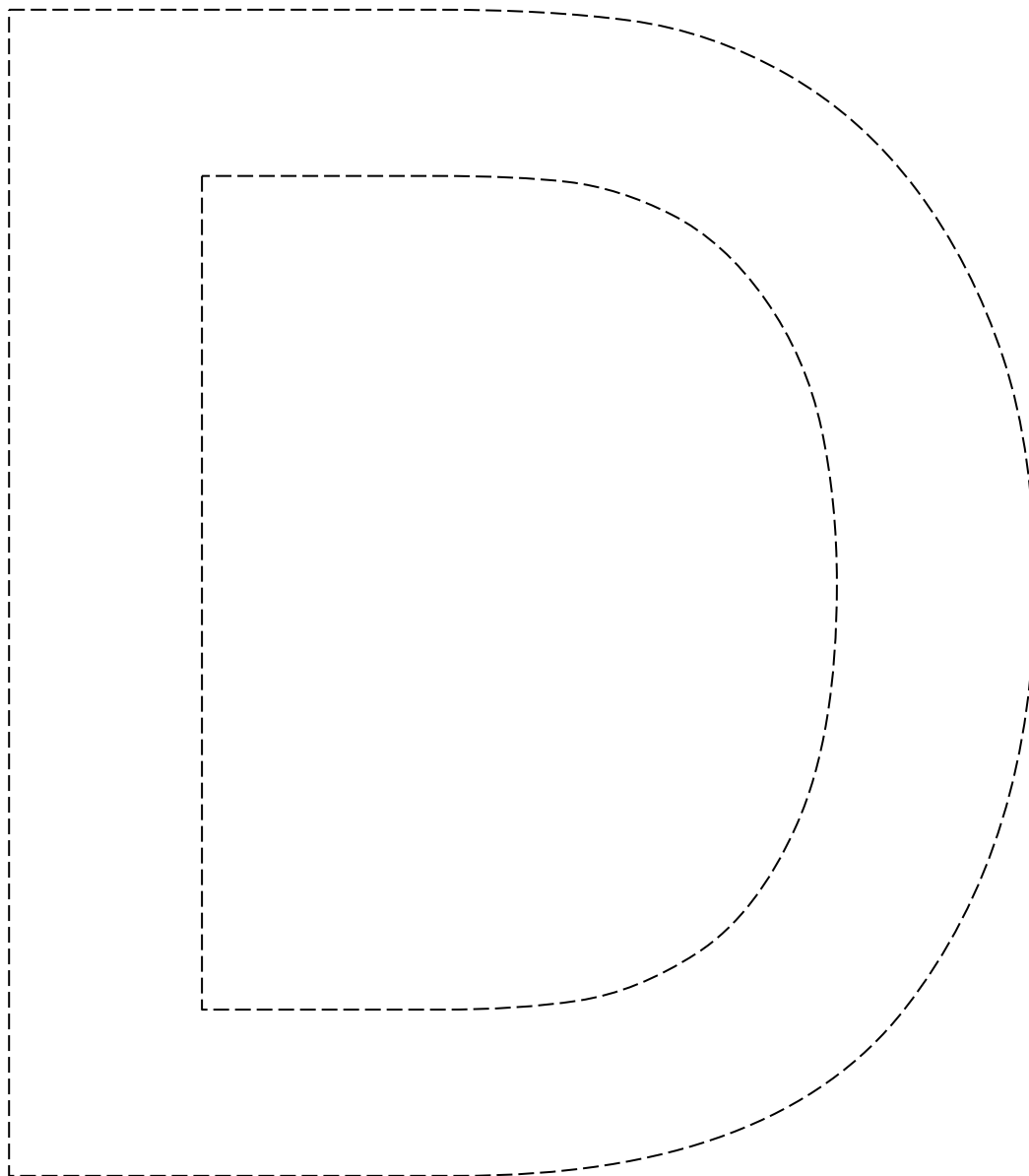

Letter D Necklace – cut out the dogs, punch one or two holes at the top of each, and string on yarn

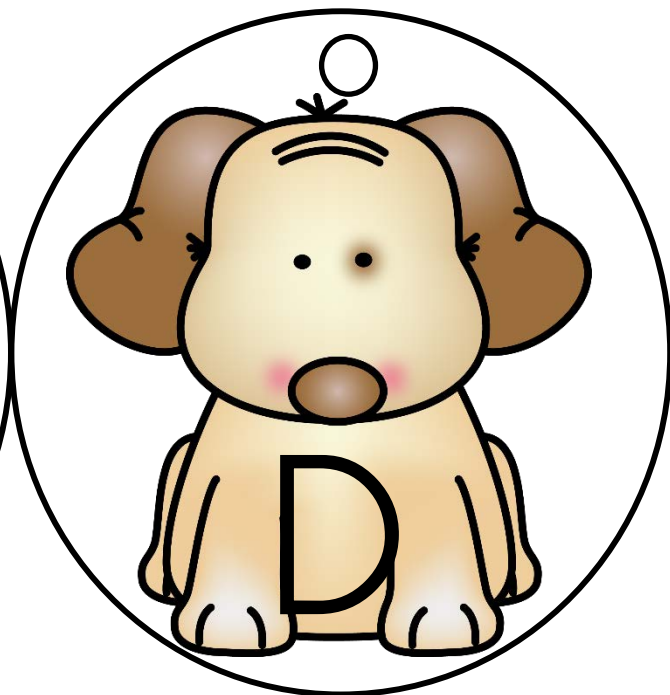
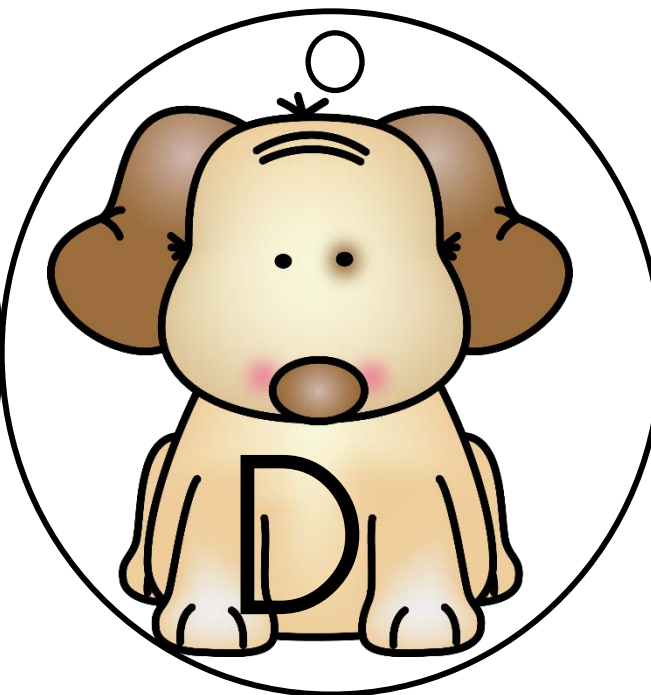
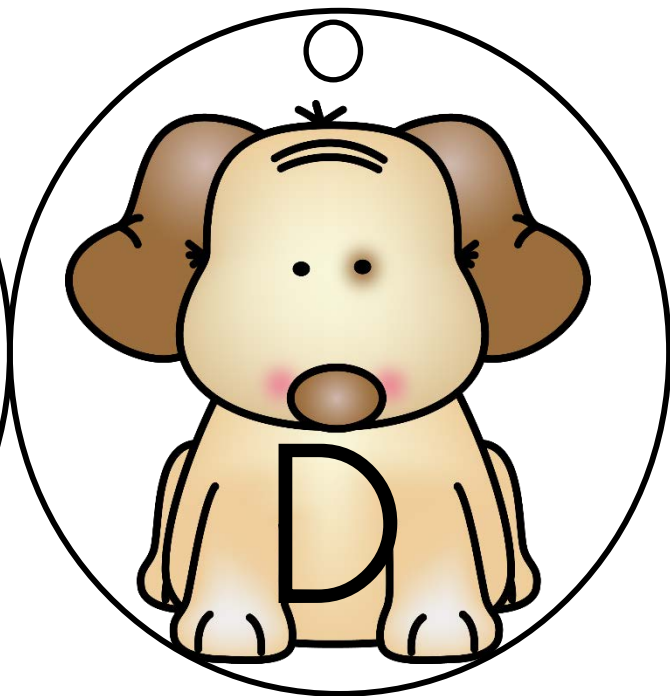
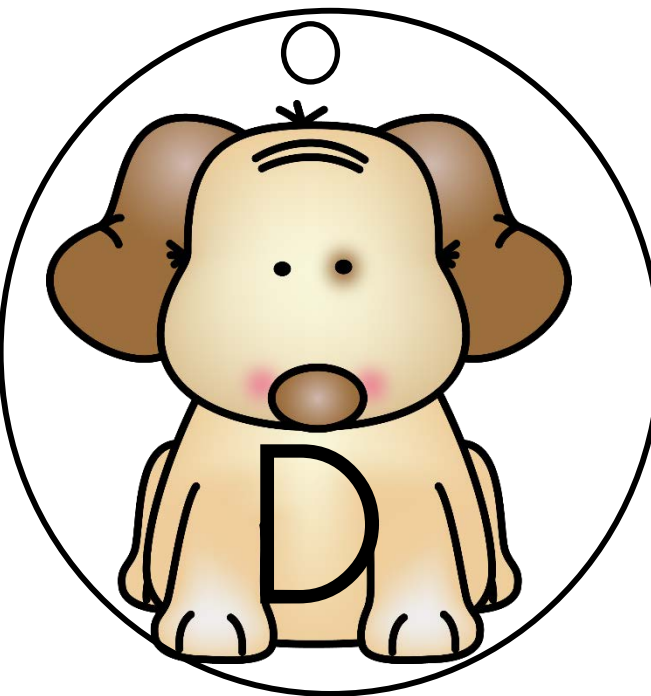
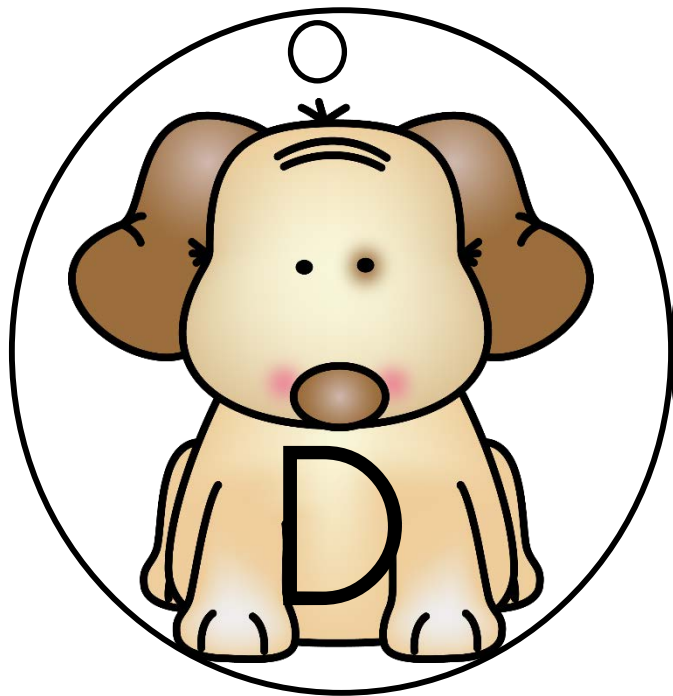

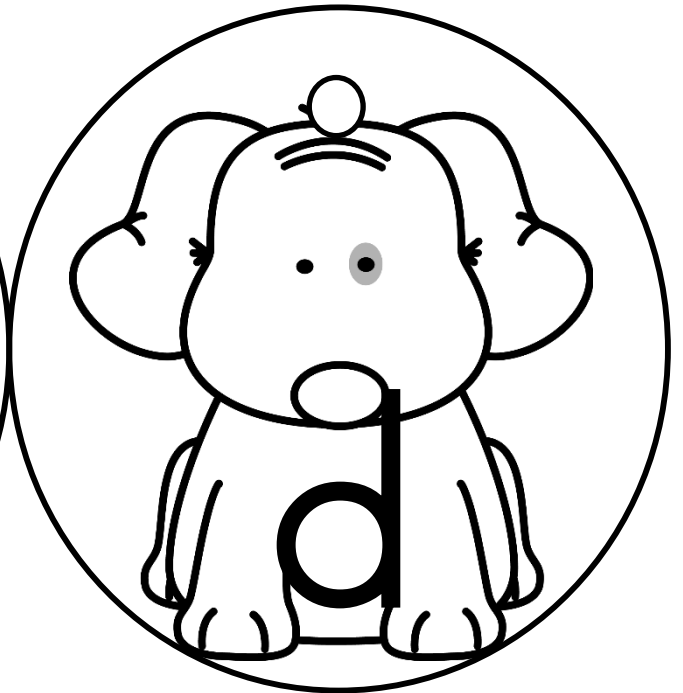
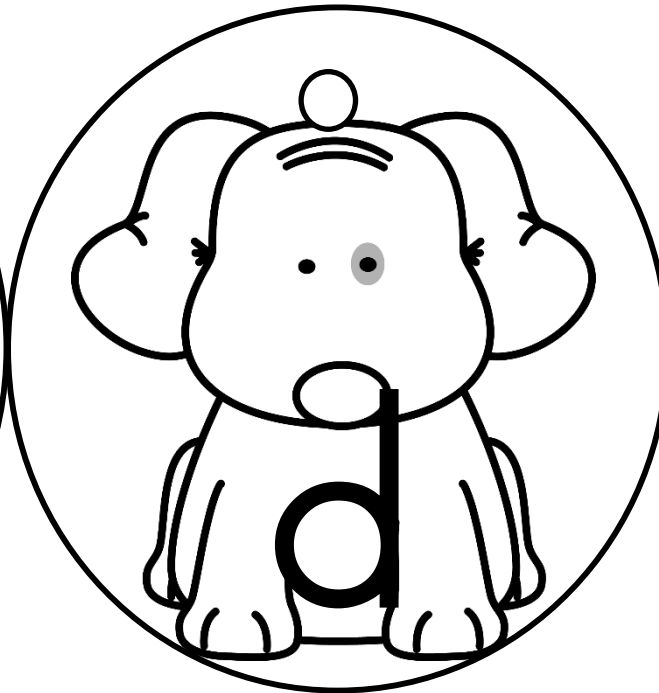
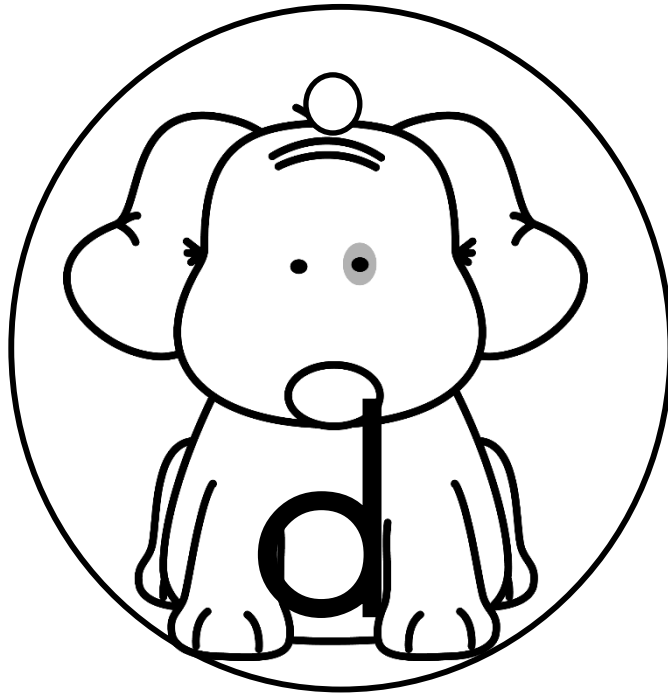
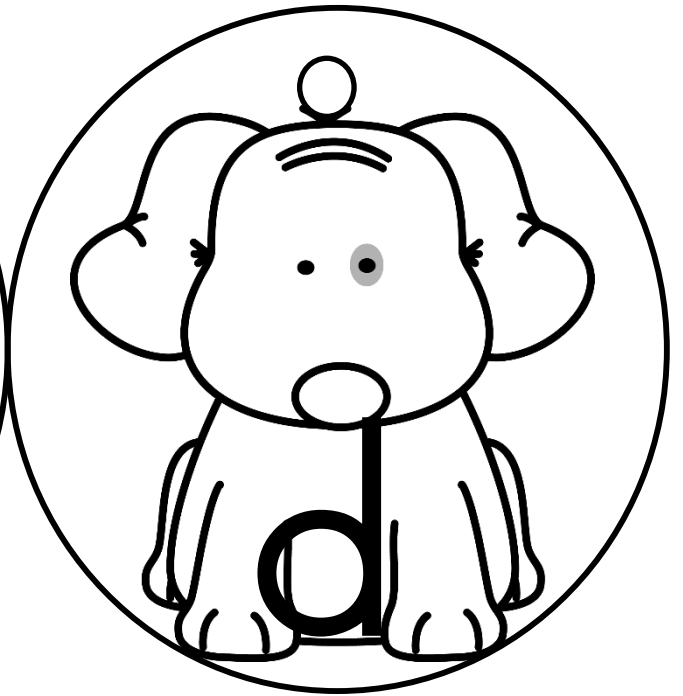
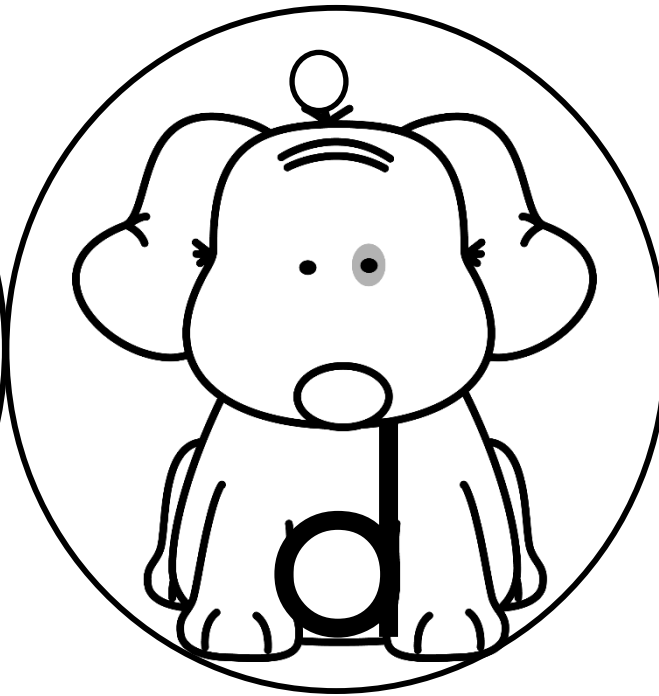
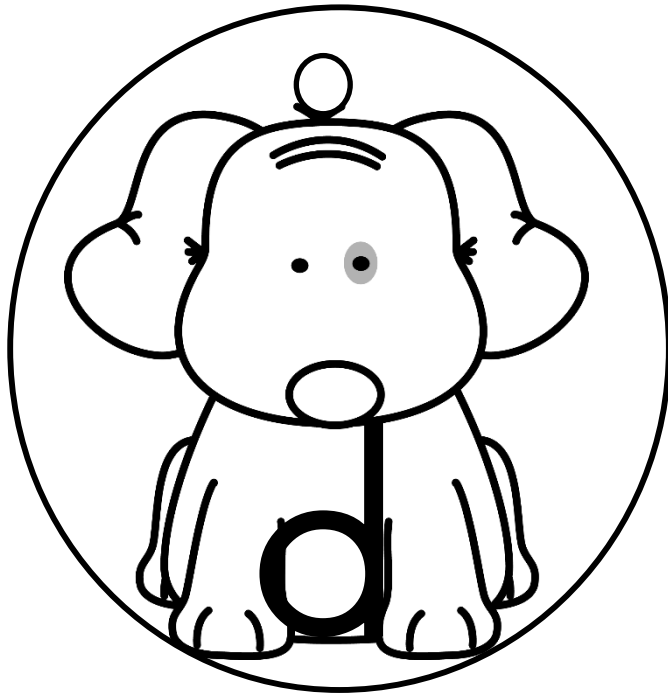

Tape or glue

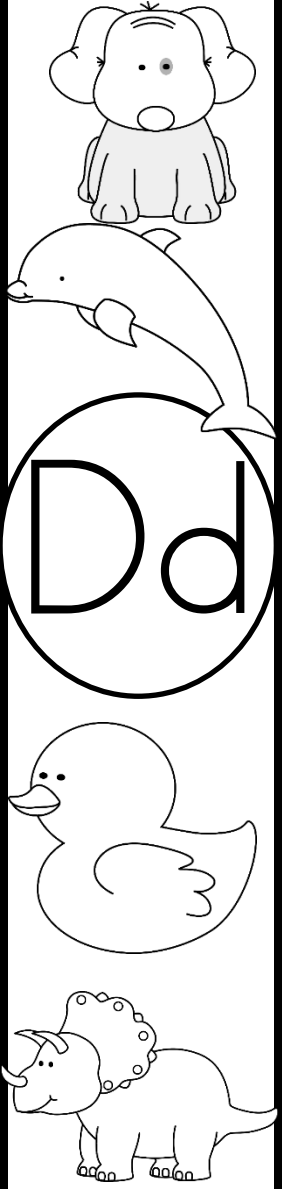

Tape or glue

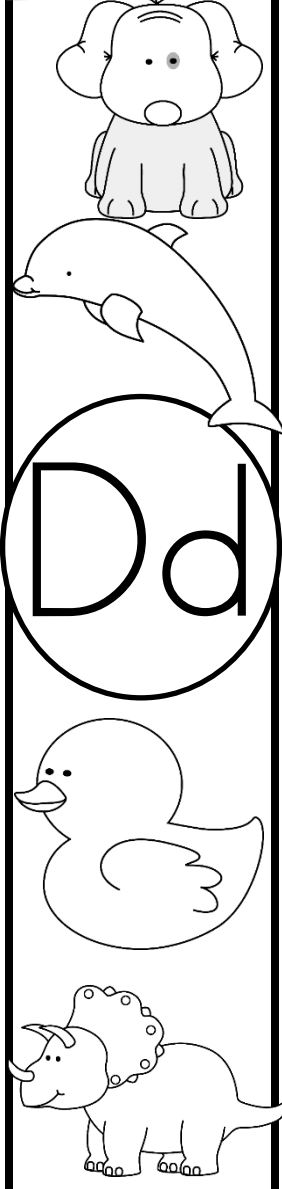

Tape or glue

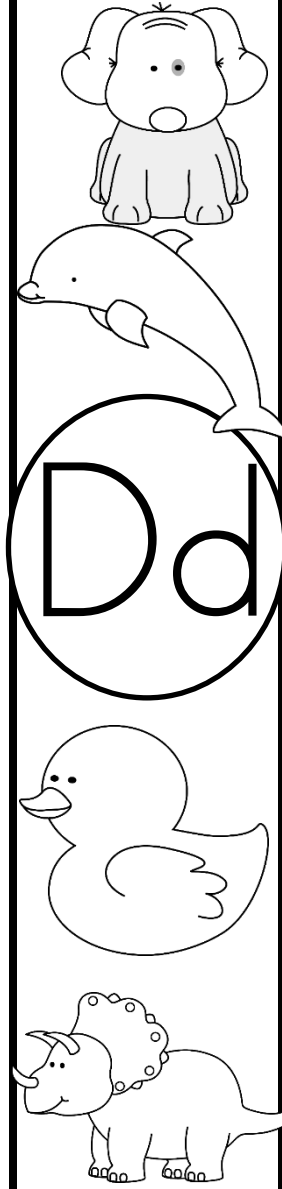

Tape or glue

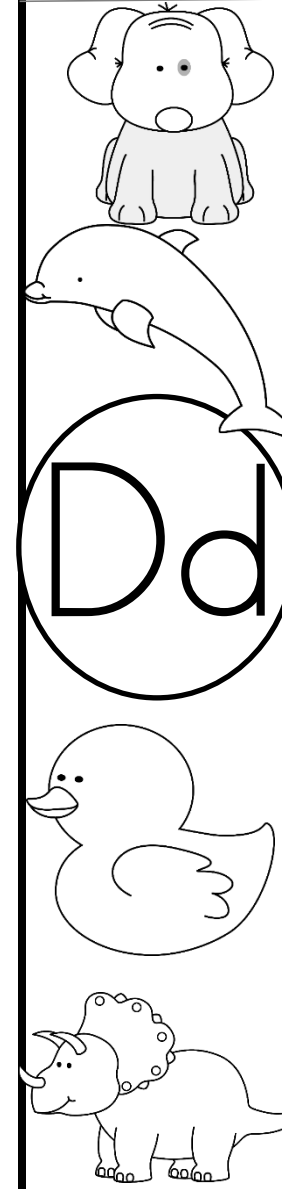

Tape or glue

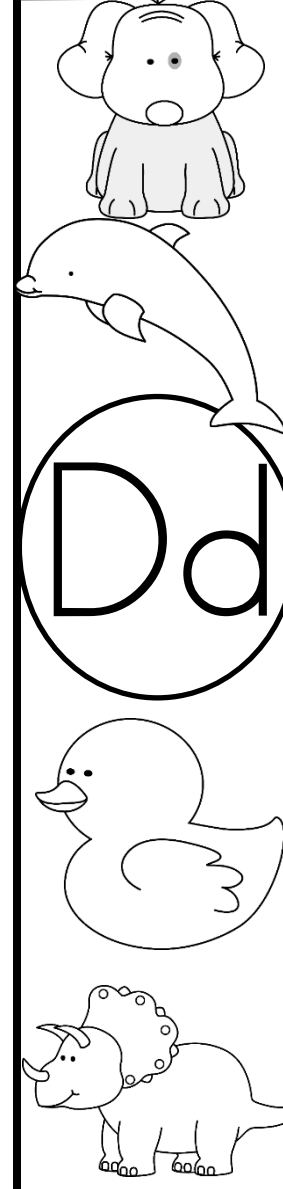

Letter D Bracelet Bands

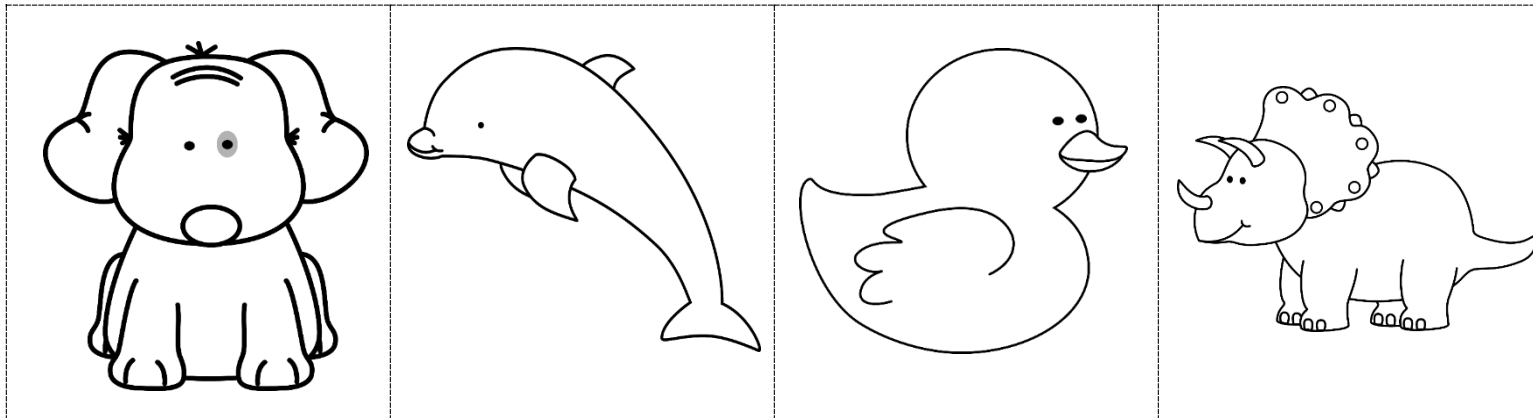
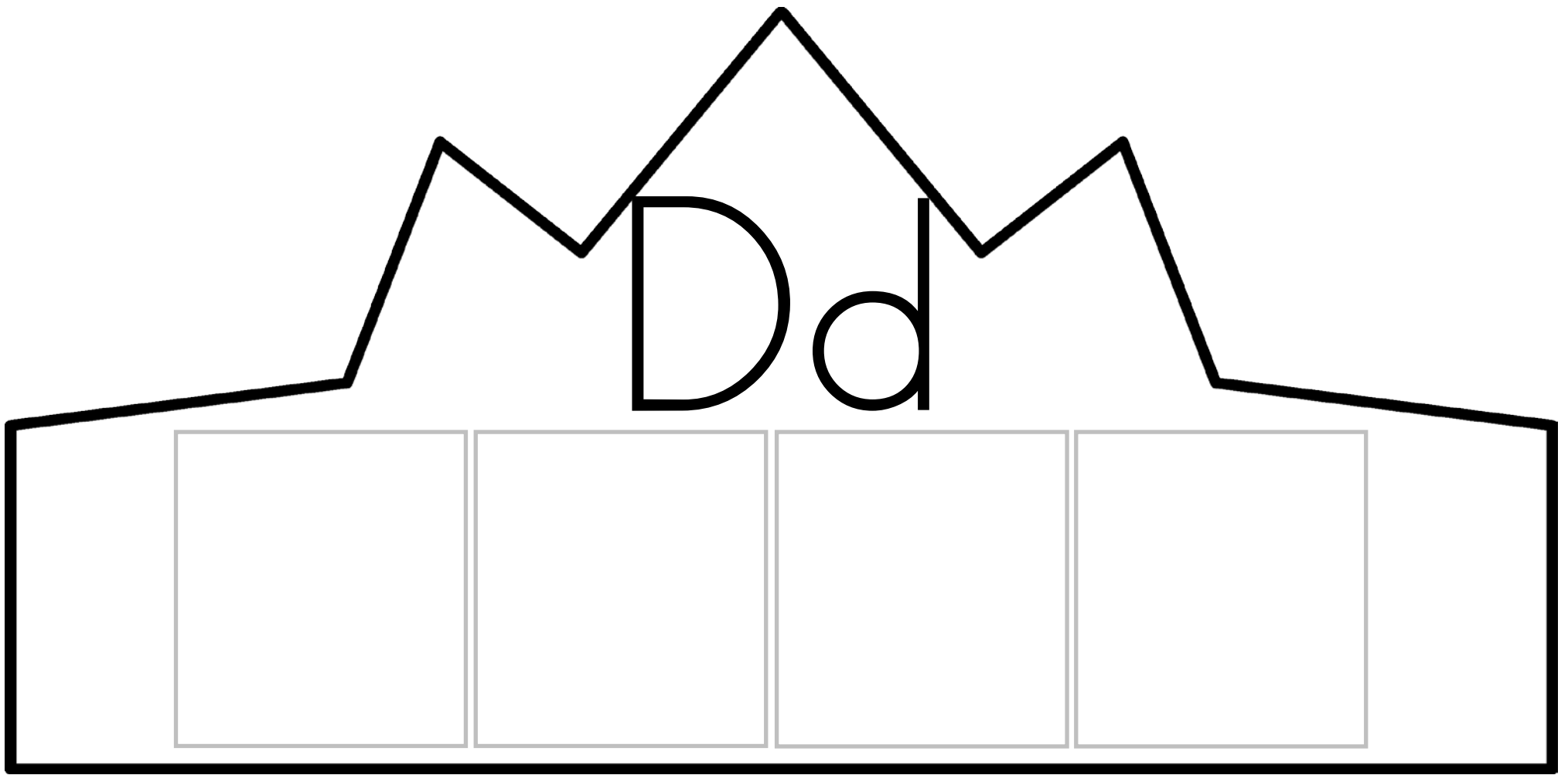

Letter D Crown: Cut out the crown. Cut and paste the pictures onto the crown. Staple a sentence strip or construction paper strip onto the crown to make a head band.

Cut out the DOUGHNUT cards. Sort the DOUGHNUTS with a D into the jar.



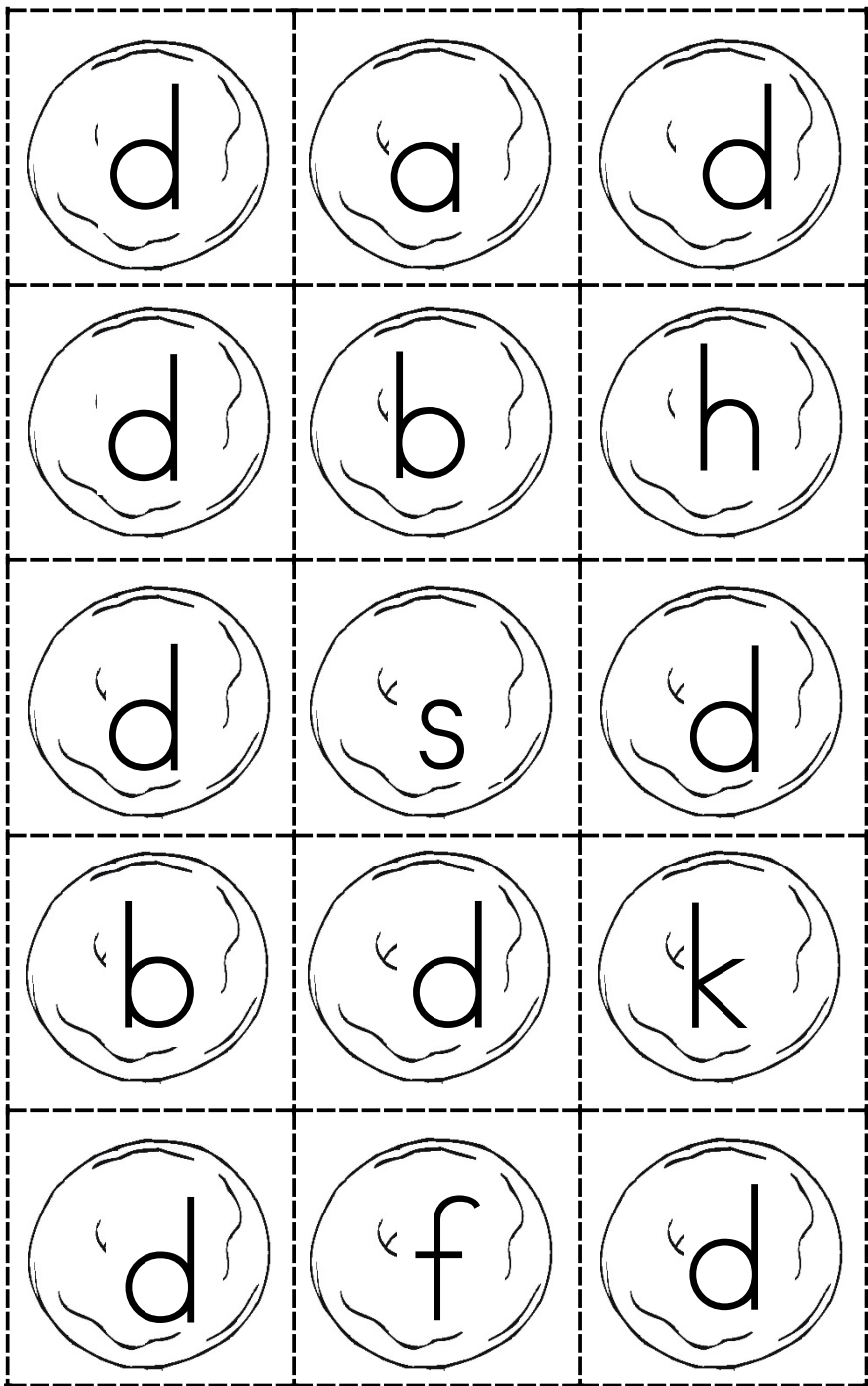

Cut out the DOUGHNUT cards. Sort the DOUGHNUTS with a d into the jar.

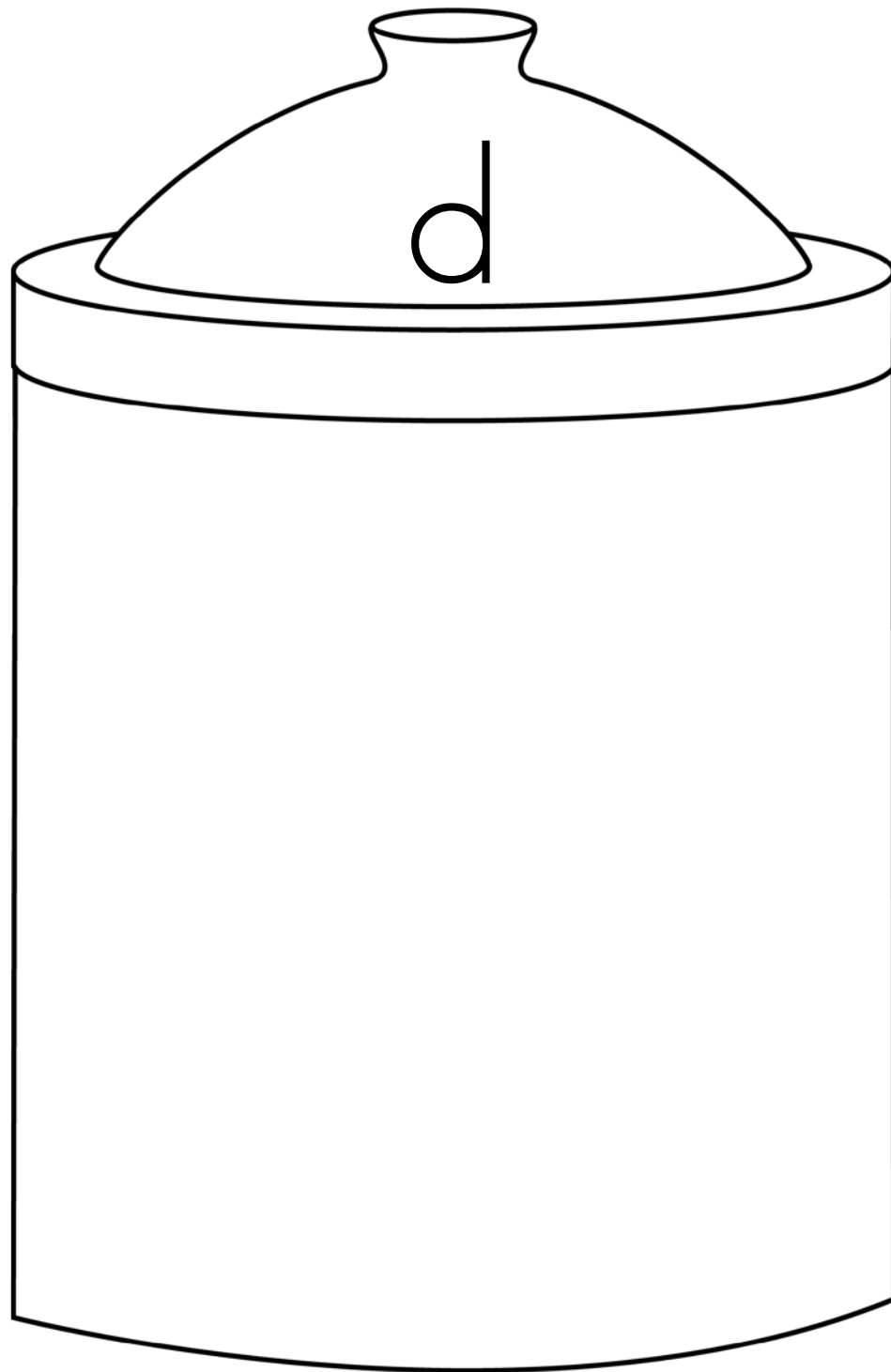

D for Dog and Dog food

D

d



Play Dough Mat – Make some dog food for the dog.

D for Dinosaurs

D

d

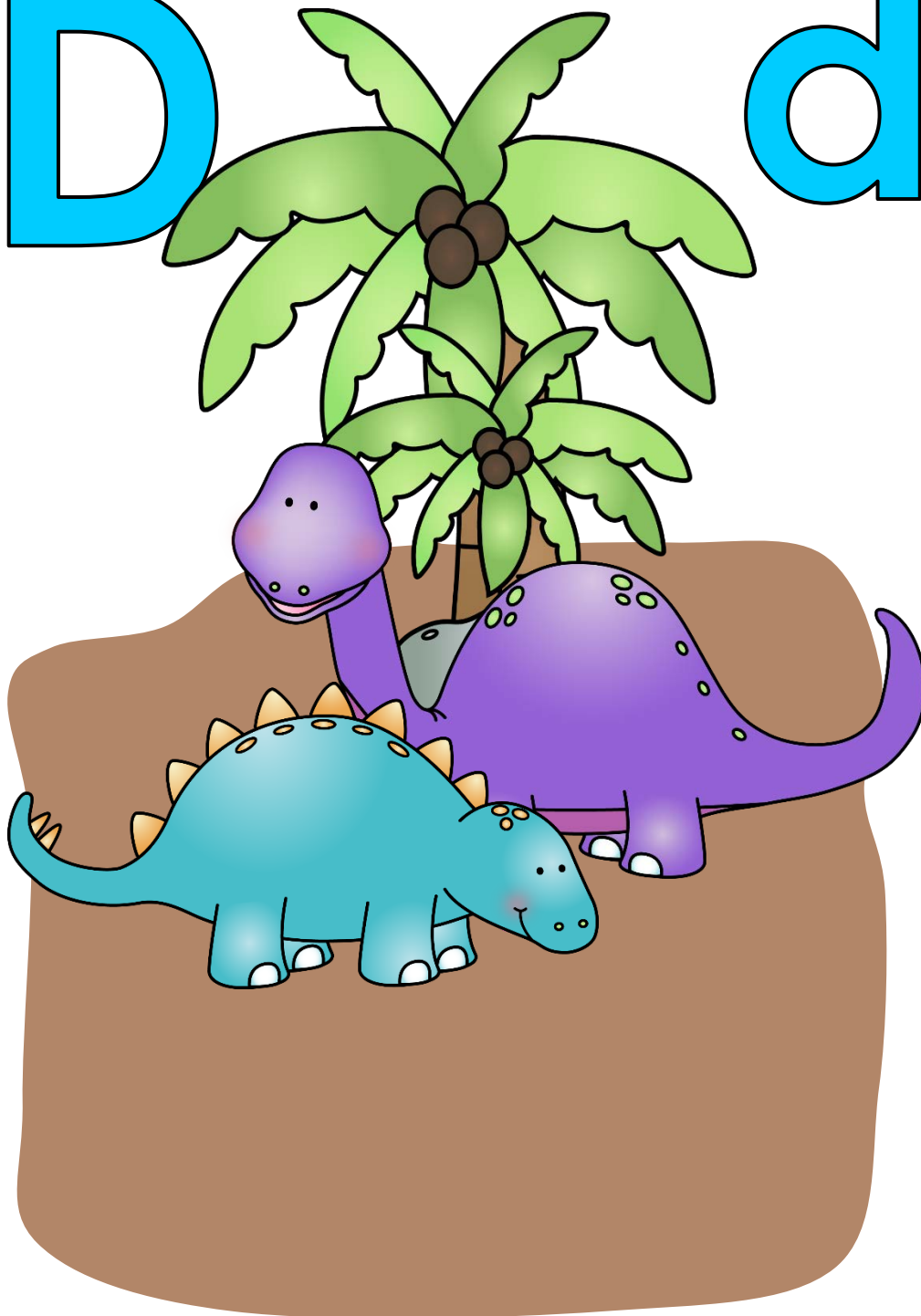

Play Dough Mat – Make some dinosaur eggs.

LACING CARD – Print on cardstock, and cut out. Punch holes around the edge. Children lace with yarn or a shoelace.



LETTER PUZZLE – print 2 copies on cardstock. Cut up one copy and match to the other.

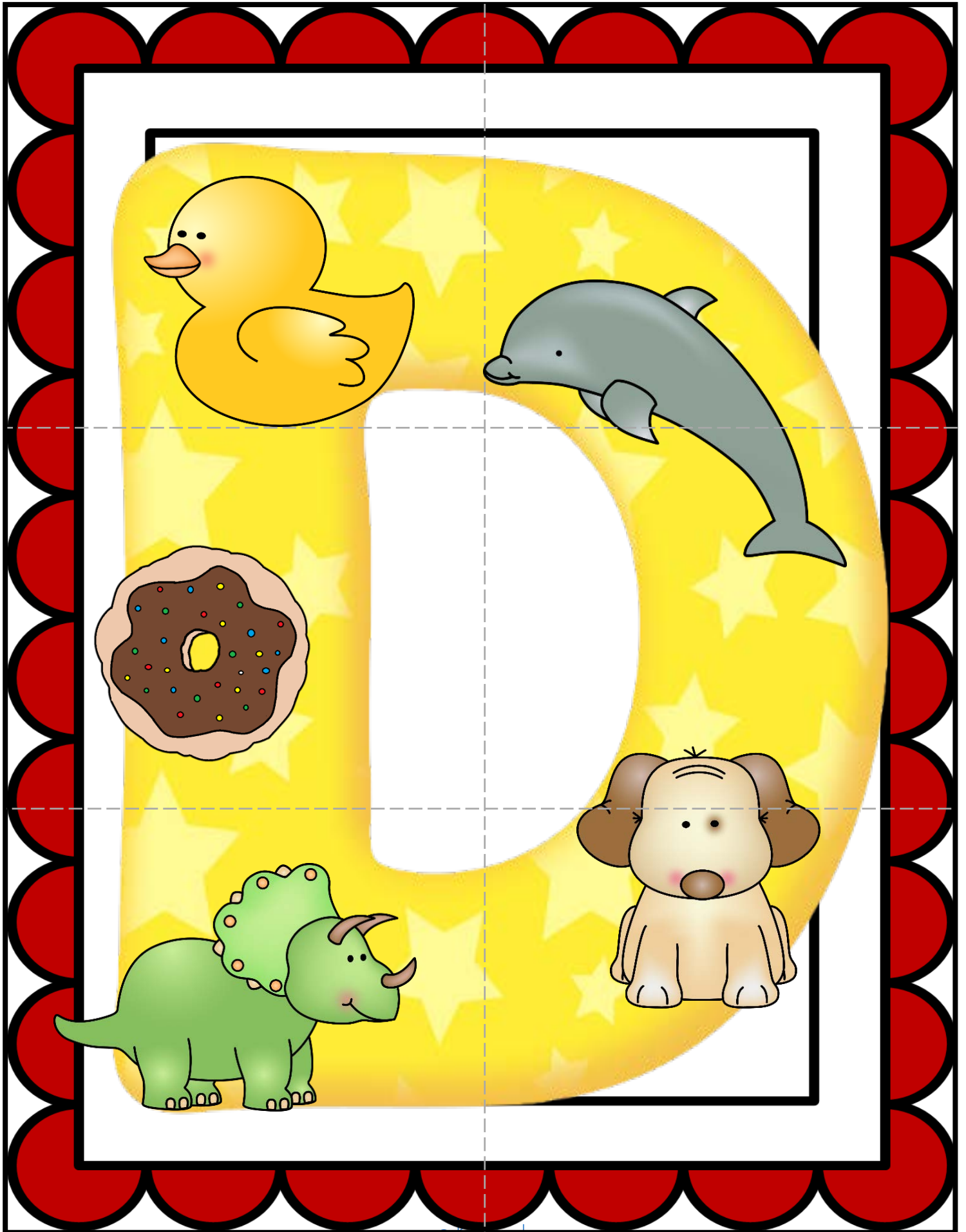

STICK PUPPETS – print on cardstock, cut out, tape on a craft stick for a handle

